

# Excalibur

## EX-16, EX-21, EX-30

### Scroll Saws

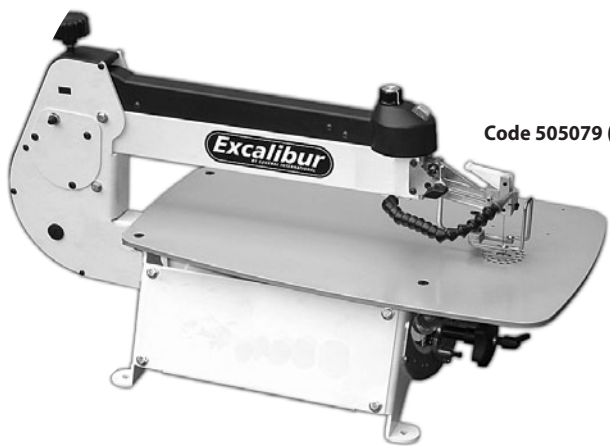

Code 505079 (EX-16)

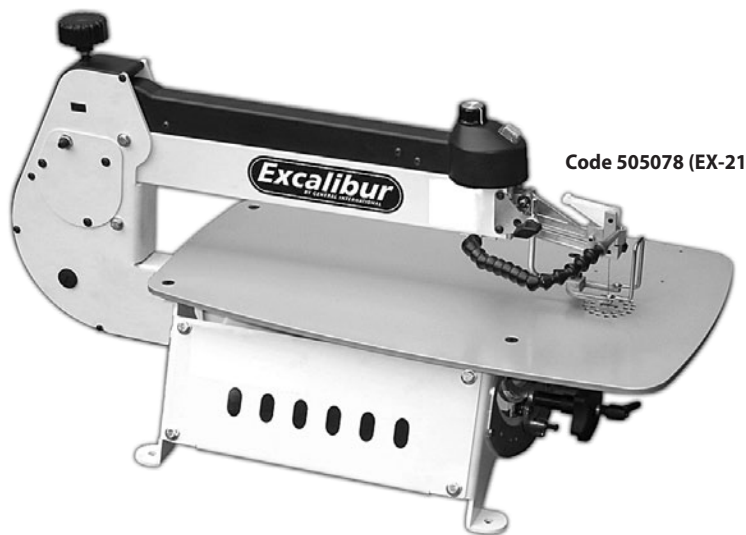

Code 505078 (EX-21)



Code 505077 (EX-30)



Code 505055 (EX-21)  
Limited Edition

# Index of Contents

	Page
Index of Contents	02
Introduction/Warranty	02
Rules For Safe Operation	03
Safety Instructions	04
Electrical Requirements	05
Identification of Main Parts & Components	06
Unpacking & Set Up	07
Installation & Assembly	07-08
Choosing & Installing a Saw Blade	08-09-10
Operating Instructions	10-11-12-13
Maintenance, Adjustments & Servicing	14-15
Changing the Fuse	15
Specifications	15
Optional Accessories	16
Stand Assembly	17
EX-16 Parts Breakdown/List (A,B)	18-19-20-21
EX-21 Parts Breakdown/List (A,B)	22-23-24-25
EX-30 Parts Breakdown/List (A,B)	26-27-28-29
EX-16, EX-21, EX-30 Drive Assembly Breakdown/List (C)	30-31
Wiring Diagram	32
Notes	33-34-35

## Introduction/Warranty

**THANK YOU** for purchasing the Excalibur model EX-16, EX-21 & EX-30 scroll saw. The scroll saws has been carefully tested and inspected before shipment and if properly used and maintained, will provide you with years of reliable service. To ensure optimum performance and trouble-free operation, and to get the most from your investment, please take the time to read this manual before assembling, installing and operating the unit.

The manual's purpose is to familiarize you with the safe operation, basic function, and features of this scroll saw as well as the set-up, maintenance and identification of its parts and components. This manual is not intended as a substitute for formal woodworking instruction, nor to offer the user instruction in the craft of woodworking. If you are not sure about the safety of performing a certain operation or procedure, do not proceed until you can confirm, from knowledgeable and qualified sources, that it is safe to do so.

Once you've read through these instructions, keep this manual handy for future reference.

### WARRANTY

All component parts of Excalibur by Axminster Tool Centre are carefully tested and inspected during all stages of production, and each unit is thoroughly inspected upon completion of assembly. Because of our commitment to quality and customer satisfaction, Axminster Tool Centre agrees to repair or replace, within a period of 2 years from date of purchase, any genuine part or parts which, upon examination, prove to be defective in workmanship or material. In order to obtain this warranty, all defective parts must be returned freight pre-paid to Axminster Tool Centre. Repairs attempted without our written authorization will void this warranty. Disclaimer: The information and specifications in this manual pertain to the unit as it was supplied from the factory at the time of printing. Because we are committed to making constant improvements, Axminster Tool Centre reserves the

right to make changes to components, parts or features of this unit as deemed necessary, without prior notice and without obligation to install any such changes on previously delivered units. Reasonable care is taken at the factory to ensure that the specifications and information in this manual corresponds with that of the unit with which it was supplied. However, special orders and "after factory" modifications may render some or all information in this manual inapplicable to your unit. Further, as several generations of this scroll saw and several versions of this manual may be in circulation, if you own an earlier or later version of this unit, this manual may not depict your unit exactly. If you have any doubts or questions contact your retailer or our support line with the model and serial number of your unit for clarification.



**Warning** The symbols below advise that you follow the correct safety procedures when using this machine.



Fully read manual and safety instructions before use



Ear protection should be worn



Eye protection should be worn



Dust mask should be worn



Keep hands away from moving parts and cutting area



**To help ensure safe operation, please take a moment to learn the machine's applications and limitations, as well as potential hazards. Axminster Tool Centre disclaims any real or implied warranty and holds itself harmless for any injury that may result from the improper use of its equipment.**

1. Be sure to read, understand and follow all safety warnings and instructions in the supplied Operator's Manual.
2. Do not operate the saw when tired, distracted, or under the effects of drugs, alcohol or any medication that impairs reflexes or alertness. Stay alert! Give your work your undivided attention.
3. Keep the work area well lit, clean and free of debris. Cluttered areas and benches invite injuries.
4. Keep children and shop visitors at a safe distance while operating the saw; do not permit them to operate the scroll saw.
5. Childproof and tamper proof your shop and all machinery with locks, master electrical switches and switch keys, to prevent unauthorised or unsupervised use. Fine particulate dust is a carcinogen that can be hazardous to health. Work in a well ventilated area and use a dust collector whenever possible.
7. Wear approved safety glasses, dust mask and nonskid footwear. Do not wear loose clothing, gloves, bracelets, necklaces or jewellery while operating the saw. Keep long hair contained by wearing protective hair covering.
8. Be sure all adjustment tools, wrenches or other clutter are removed from the machine and/or the table surface before operation. When not in use, tools should be locked-up in a dry place, out of children's reach and away from flammable substances.
9. Keep hands well away from saw blade and all moving parts. Use a brush, not hands, to clear away chips and sawdust.
10. Be sure that the saw blade is properly installed, and in the correct cutting direction, before operation. Always use a clean, properly sharpened blade. Dirty or dull blades are unsafe and can lead to accidents. Also, be sure the blade has gained full operating speed before beginning to cut.
11. Do not push or force wood into the blade. The saw will perform better and more safely when working at the rate for which it was designed. Do not use for purposes not intended.
12. Avoid working from awkward or off balance positions. Do not overreach while cutting; keep both feet on floor. Never lean over or reach behind the blade and never pull the work piece through the cut from behind.
13. Never stand or lean on the saw. Serious injury could occur if the unit is tipped over or if the blade is unintentionally contacted.
14. Use of parts and accessories NOT recommended by Axminster Tool Centre may result in equipment malfunction or risk of injury.
15. Never leave the machine unattended while running or with the power "ON".
16. Always turn off and disconnect from power source before servicing or changing accessories, blades, bits, and cutters, or before performing any maintenance or adjustments.
17. Make sure that switch is in the "OFF" position before plugging in the power cord. Do not use the saw if the power switch is defected, have defective switches replaced by an authorized service centre.
18. Make sure saw is properly grounded. If equipped with a three prong plug it should be used with a three-pole receptacle. Never remove the third prong. Avoid body contact with grounded surfaces (e.g. pipes, radiators, stoves, refrigerators).
19. Repairs to the saw should only be carried out by qualified people using original spare parts. A guard or other damaged part should be properly repaired or replaced by an authorized service centre.
20. Inspect power cords and extension wires periodically. If damaged, have them repaired by an authorized service facility. Never yank cords and wires and keep away from heat, oil, and sharp edges.
21. This tool is for indoor use only. Do not expose to rain or use in wet or damp locations.



## **Additional Safety Instructions** **Specific to this Scroll Saw**



**Because each shop situation is unique, no list of safety guidelines can ever be complete. The most important safety feature in any shop is the knowledge and good judgement of the user. Use common sense and always keep safety considerations, as they apply to your individual shop situation first and foremost in mind. If you have any doubts about the safety of an operation you are about to perform: STOP! Do not perform the operation until you have validated from qualified individuals if the operation is safe to perform and what is the safest method to perform it.**

1. Material hold-down must be properly set and remain in position during use.
2. Never reach under the table when operating or make any adjustments while the scroll saw is running.
3. Secure the saw to the work bench with clamps or mounting hardware.
4. Where possible, use clamps or a vice to secure your workpiece. It is safer than using your hand.
5. Do not lift or carry the saw by the upper arm.
6. Make sure blade tension is properly adjusted.
7. Avoid awkward hand positions where a sudden slip could cause a hand to move into the saw blade. Do not place fingers or hands in the path of the saw blade.
8. When removing short workpieces, or cleaning up around the table, be sure that the switch is in the OFF position and that the blade has come to a complete stop.
9. Never turn the saw ON before making sure that the table is clear except for the workpiece and related feed or support devices for the operation planned.
10. Check for proper blade size and type.
11. Do not attempt to saw stock that does not have a flat surface unless a suitable support is used.
12. Turn off motor if the material resists being backed out of an incomplete cut. Use appropriate speed for applications.
13. CAUTION: Some wood contains preservatives such as copper chromium arsenate (CCA) which can be toxic. When cutting these materials, extra care should be taken to avoid inhalation and to minimize skin contact.
14. Always use a dust mask and safety glasses when sawing.
15. Keep guards in place and in working order.
16. Make sure your fingers do not contact the terminals of the power cord plug when plugging in or unplugging the saw.
17. Never overfeed or force work into the blade.
18. Check for alignment and binding of all moving parts, broken parts, mounting and any other conditions that may affect the saw's operation.
19. Keep handles dry and free from oil and grease.

---

**To avoid electrical shock, ensure machine is properly grounded. Do not operate in damp conditions. Disconnect from power supply before servicing. Replace fuse with the same type and rating only - 3 Amp.**

**Be sure to read and understand owner's manual before operating.**

---



# Electrical Requirements



Before connecting the machine to the power source, verify that the voltage of your power supply corresponds with the voltage specified on the motor I.D. nameplate. A power source with greater voltage than needed can result in serious injury to the user as well as damage to the machine. If in doubt, contact a qualified electrician before connecting to the power source.



This tool is for indoor use only. Do not expose to rain or use in wet or damp locations.

## GROUNDING INSTRUCTIONS

In the event of an electrical malfunction or short circuit, grounding reduces the risk of electric shock. The motor of this machine is wired for 240V single phase operation and is equipped with a 3-conductor cord and a 3-prong grounded plug to fit a grounded type receptacle, **a**



**a**



**Note: The use of an adaptor plug is illegal in some areas. Check your local codes.**

DO NOT MODIFY THE PLUG PROVIDED.

If it will not fit your receptacle, have the proper receptacle installed by a qualified electrician.

CHECK with a qualified electrician or service person if you do not completely understand these grounding instructions, or if you are not sure the tool is properly grounded.

## EXTENSION CORDS

USE ONLY 3-WIRE EXTENSION CORDS THAT HAVE 3-PRONG GROUNDING PLUGS AND 3-POLE RECEPTACLES THAT ACCEPT THE TOOLS' PLUG. REPAIR OR REPLACE A DAMAGED OR WORN POWER CORD OR PLUG IMMEDIATELY.

If you find it necessary to use an extension cord with your machine make sure the cord rating is suitable for the amperage listed on the motor I.D. plate. An undersized cord will cause a drop in line voltage resulting in loss of power and overheating. The accompanying chart shows the correct size extension cord to be used based on cord length and motor I.D. plate amp rating. If in doubt, use the next heavier gauge. The smaller the number the heavier the gauge.

AMPERES (AMPS)	EXTENSION CORD LENGTH					
	25 FEET	50 FEET	75 FEET	100 FEET	150 FEET	200 FEET
<5	16	16	16	14	12	12
5 TO 8	16	16	14	12	10	NR
8 TO 12	14	14	12	10	NR	NR
12 TO 15	12	12	10	10	NR	NR
15 TO 20	10	10	10	NR	NR	NR
21 TO 30	10	NR	NR	NR	NR	NR

\*Based on limiting the line voltage drop to 5V at 150% of the rated amperes.

**NR = Not Recommended**

# Identification of Main Parts & Components



**16" 21" & 30" SCROLL SAW**  
EX-16, EX-21 & EX-30

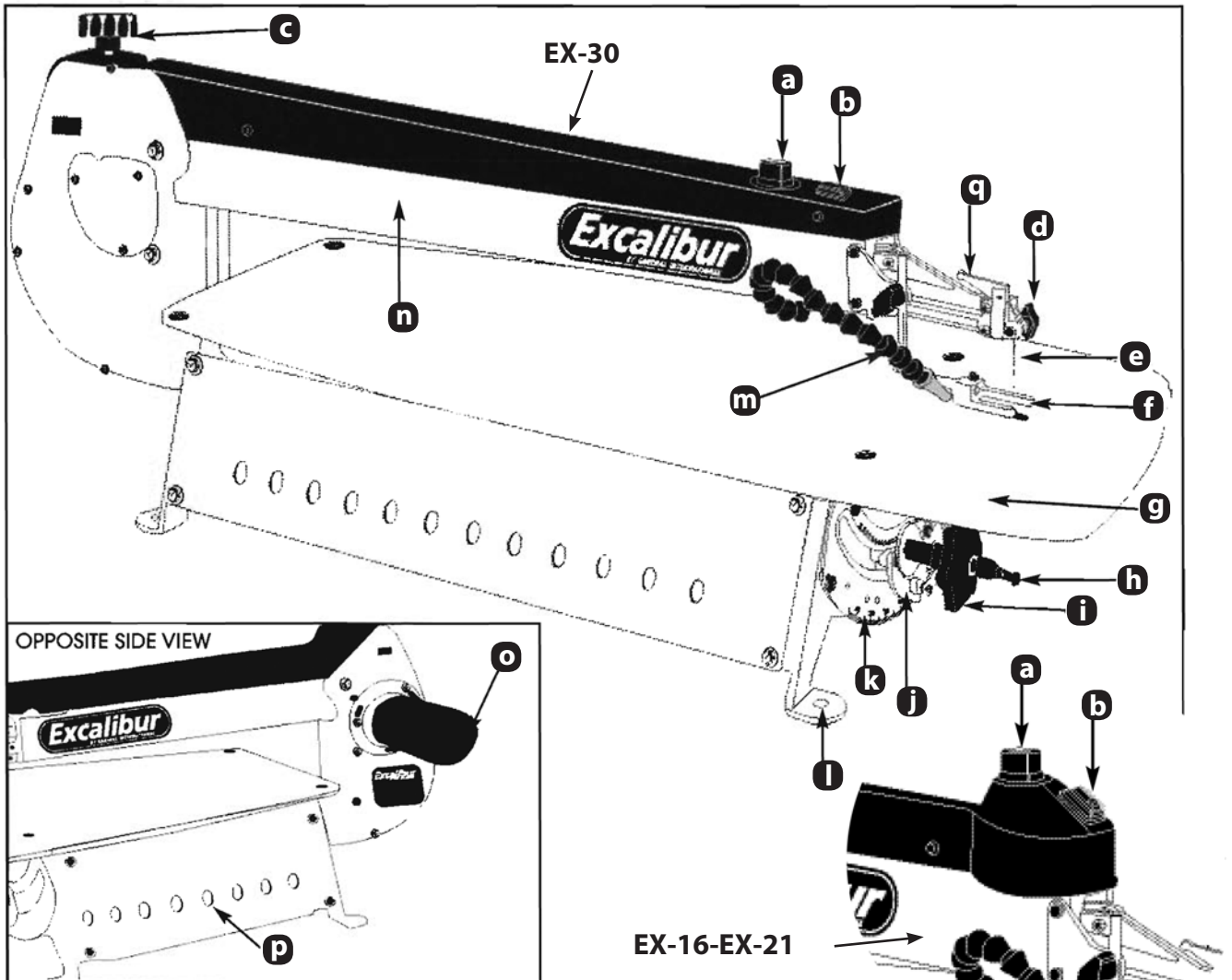

- |  |                                 |
|--|---------------------------------|
| <b>a</b> VARIABLE BLADE SPEED CONTROL KNOB | <b>i</b> TILT HANDLE            |
| <b>b</b> ON/OFF SWITCH                     | <b>j</b> ANGLE INDICATOR        |
| <b>c</b> UPPER ARM TENSIONER               | <b>k</b> ANGLE ADJUSTMENT SCALE |
| <b>d</b> BLADE CLAMP                       | <b>l</b> MOUNTING HOLES (4)     |
| <b>e</b> BLADE                             | <b>m</b> BLOWER                 |
| <b>f</b> WORKPIECE HOLD DOWN               | <b>n</b> UPPER ARM              |
| <b>g</b> TABLE                             | <b>o</b> MOTOR                  |
| <b>h</b> BLADE TILT LOCKING LEVER          | <b>p</b> BLADE HOLDER SOCKETS   |
|  | <b>q</b> BLADE TENSION LEVER    |

## UNPACKING

Carefully unpack and remove the scroll saw and its components from the box and check for missing or damaged items as per the list of contents below.

**Note:** Please report any damaged or missing items to your General International distributor immediately.

Once the parts have been removed from the packaging, you should have the following items:

LIST OF CONTENTS	QTY
A - SCROLL SAW .....	1
B - POWER CORD .....	1
C - 3 MM ALLEN KEY .....	1
D - BLADE.....	1

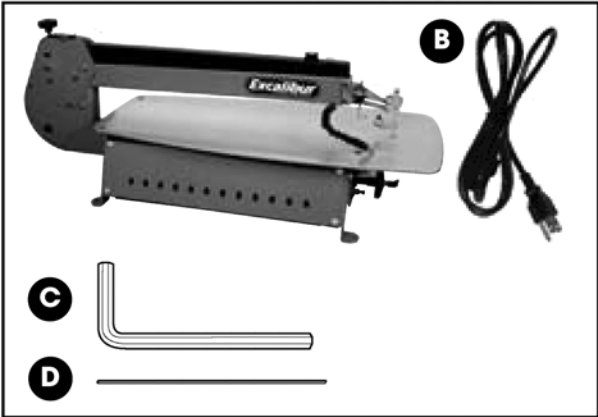
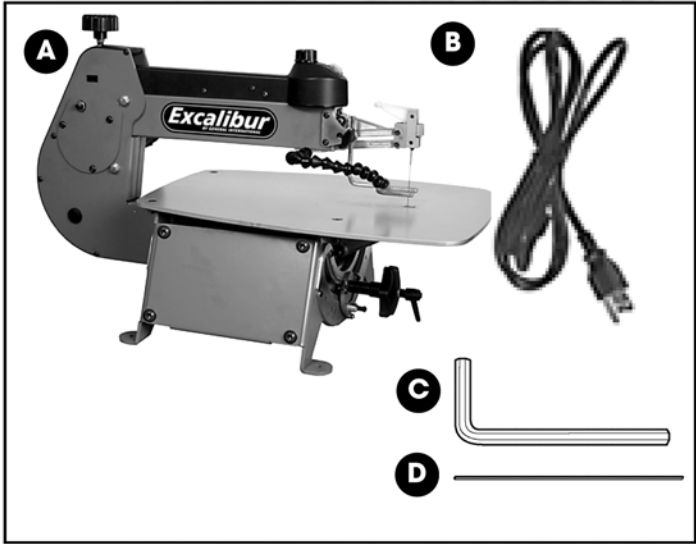
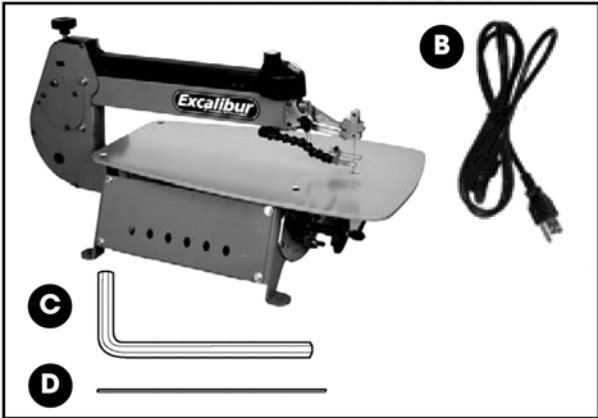

## Installation & Assembly

Unscrew the 4 shipping bolts and remove the saw from the protective plywood shipping base. For your convenience this scroll saw is shipped from the factory partially assembled and requires only minimal assembly and set-up before being put into service.



**Before starting the assembly, make sure that the switch is in the "OFF" position and that the power cord is unplugged. Do not plug in or turn on the scroll saw until you have completed the assembly and installation steps described in this section of the manual.**

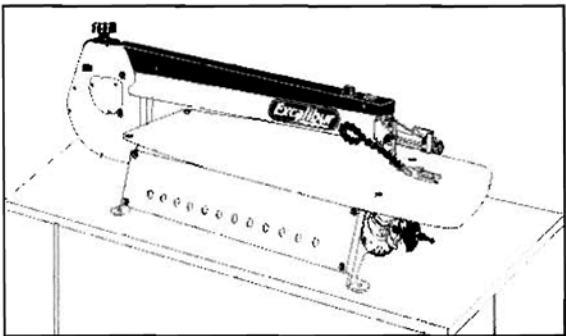

The unit should be installed on a flat, sturdy and stable surface able to support the weight of the machine and the workpiece with ease.

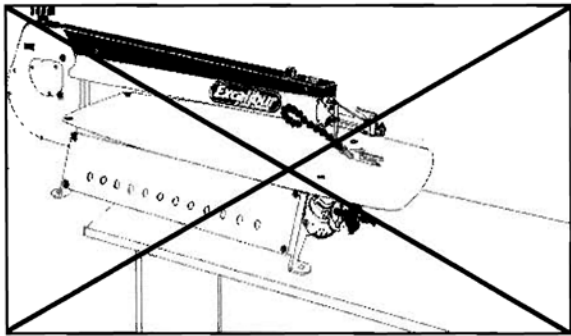

Never install the machine over the edge of a table or workbench.

# Installation & Assembly

## Saw guard assembly

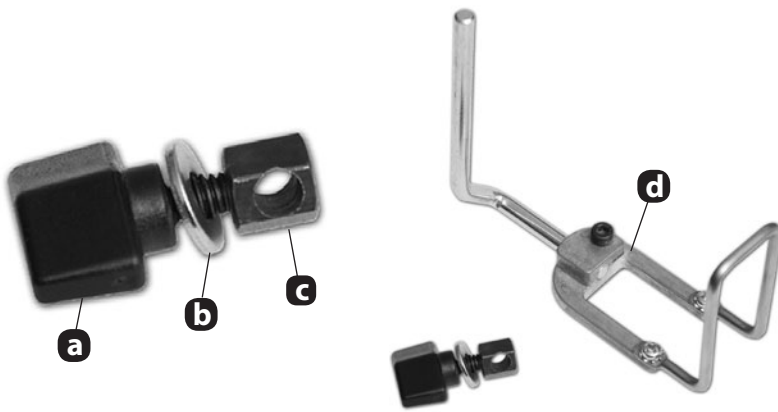

Slot the guard clamping arm (d) through the pre-drilled hole in the hexagon clamp (c). Insert the hexagon clamp (c) into the brackets hexagon recess, place the washer (b) over the hexagon clamp thread and secure using the butterfly clamping knob (a).

**NOTE: DO NOT OVERTIGHTEN otherwise you may strip the thread**

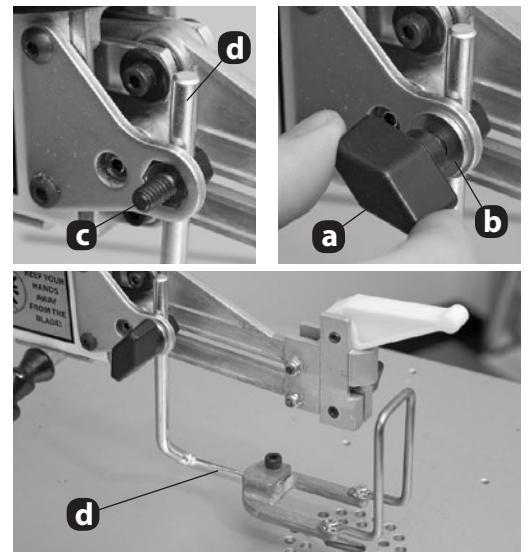

Saw guard assembly (d) assembled

## Mounting to a work surface

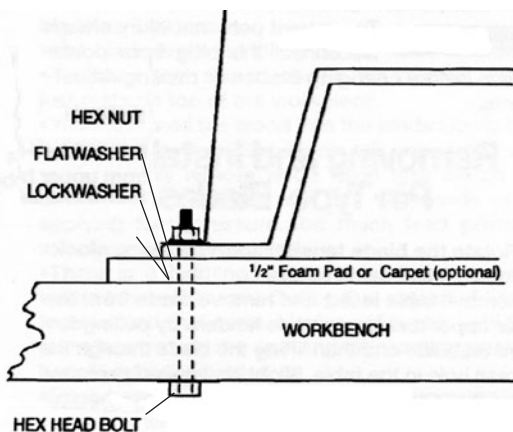
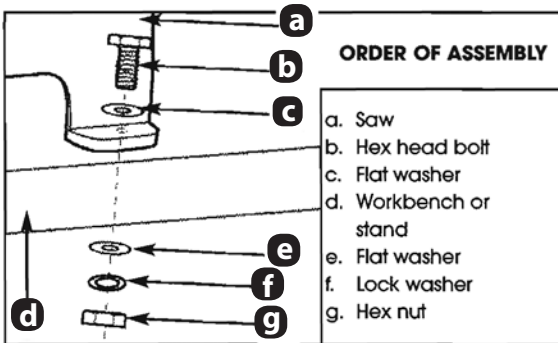

It is strongly recommended that you mount the machine to a workbench or to a purpose built stand, a pad between the scroll saw and the workbench/stand is also recommended to reduce vibration.

Drill four 8mm holes in your workbench/stand and secure using nuts bolts washers (Not Included).

## Attaching the power cord



Plug the female end of the power cord into the socket at the rear of the saw as shown.

# Choosing & Installing a Saw Blade

## Blade Selection

Blade selection is dependent on the type and thickness of the material being cut, but is also a matter of experience and personal preference. There are numerous types of blades available on the market specifically suited for various cutting applications such as metal-cutting and spiral blades which cut in all directions. Try test-cutting with a sample of each to determine which blade works best for you with different materials. Replacement and specialty blades can be purchased from a variety of sources. Ask your local tool or scroll saw dealer for suggestions for **unpinned 5" scroll saw blades** based on what is available in your area.



# Choosing & Installing a Saw Blade

Some general guidelines to consider when choosing blades:

- Wide, thick blades with coarse teeth are suited to cutting straight lines and sweeping curves, but will not turn tight corners. They will cut aggressively and leave a fairly smooth finish, but may leave burn marks if the work piece is turned too tightly.
- Narrower, thinner blades with finer teeth will cut more slowly, but will turn much tighter corners for cutting very intricate work. They will impart a very smooth, burnished finish that requires no sanding.
- Consider material thickness when selecting blades. Ensure that a minimum of two or three teeth are in contact with the workpiece at all times. For example, when cutting 1/8" thick material, use a blade with a minimum of 16-20 teeth per inch.

## SKIP TOOTH



Regular evenly spaced tooth pattern. Considered the most common of scroll saw blades, they are available in the widest range of sizes and provide a good combination of fast cutting action with good chip clearance and a relatively smooth finish.

BLADE	WIDTH	THICKNESS	TEETH/INCH	
#2/0	.022	.010	28	For extremely intricate sawing. Very tight cuts in 1/16" - 1/4" wood veneer, plastic, hard rubber, pearl, etc.
#0	.024	.011	25	
#2	.029	.012	20	For tight radius work with thin materials, 3/32" - 1/2" wood veneer, wood, bone, fiber, plastic, etc.
#4	.035	.015	15	
#5	.038	.016	12.5	For close radius work in materials 1/8" or thicker. Good for sawing hard and soft woods, bone, horn, plastic, etc.
#6	.041	.016	12.5	
#7	.045	.017	11.5	Popular sizes for cutting hard and soft woods, 3/16" up to 2". Also cuts plastic, paper, felt, bone, etc.
#9	.053	.018	11.5	
#11	.059	.019	9.5	
#12	.062	.024	9.5	

## REVERSE TOOTH



Reverse teeth at the bottom of the blades prevent splintering to the underside of the workpiece.

BLADE	WIDTH	THICKNESS	TEETH/INCH	
#2/0R	.026	.011	28/20	Same applications as Skip Tooth blades.
#2R	.029	.012	20/13	
#5R	.038	.016	12.5/9	
#7R	.049	.018	11.5/8	
#9R	.054	.019	11.5/8	
#12R	.062	.062	9.5/6	

## DOUBLE TOOTH



Fast, clean cutting and very efficient chip clearance.

BLADE	WIDTH	THICKNESS	TEETH/INCH	
#1D	.026	.013	30	Same applications as Skip Tooth blades.
#3D	.032	.014	23	
#5D	.038	.016	16	
#7D	.044	.018	13	
#9D	.053	.018	11	
#12D	.061	.022	10	

## Blade storage

There are 12 sockets (mounting holes) on either side of the base of the saw to hold blade storage "test tubes" (tubes not supplied). Most blade retailers sell blades either already in the tubes or will be able to sell spare tubes separately. Storing your spare blades in tubes, by size, right on the base of the machine can be a great way to organize your spare blades so that they are handy and available when needed.



# Choosing & Installing a Saw Blade

## Installing or changing blades



Always turn off and unplug the machine before removing, handling or changing blades.

1. Remove an installed, worn or broken blade by flipping the blade tension lever forward (position ①), then loosening the thumbscrews ③ and ④ on the upper and lower blade mounts ② and ⑤. (See Fig. 1 to 3)
2. Remove the blade.
3. With the blade teeth facing forward, slip one end of the blade through the hole in the table and fit each end of the blade into the corresponding upper and lower blade mounts, then tighten the thumbscrews firmly by hand only – do not use tools.

**Note: Overtightening the blade clamp thumbscrews can cause premature wear to the blades gripping surface and result in blade slippage.**

4. Push the blade tension lever back (position ②) to apply tension on the blade.

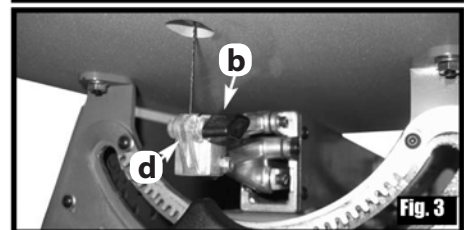
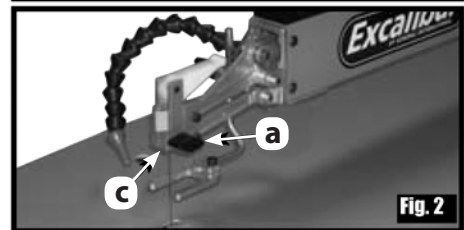
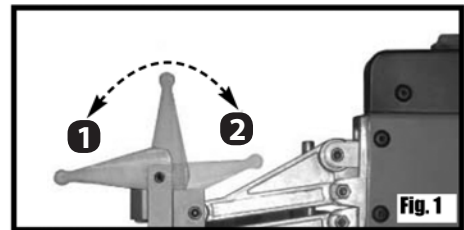

**Helpful Hints on blade tension:** Determining correct blade tension is somewhat subjective. It is learned through experience and is somewhat dependant on personal preference. A properly tensioned blade will last longer and be much less likely to break prematurely. If the blade tension is too loose, you will notice that the blade will have a tendency to drift or slip off-line when cutting and you may also experience excessive vibration or unusual noise. A blade that is too tight will break prematurely.

Assuming the blade has been properly installed in the blade mounts, when the blade tension lever is pushed fully back towards the rear of the saw, the blade should be properly tensioned.

Test the blade tension by lightly plucking on the blade, like you would a guitar string, with your finger. If the blade is tight and tensioned correctly you will get a clear and even note. If so, you are ready to proceed to operating and cutting with the saw.

## On/Off switch

A simple, dust protected rocker style on/off switch ① is located on the top of the saw. (See Fig. 5)

## Adjusting the blade speed

The Ex-30 Scroll Saw is equipped with a variable blade speed control which allows you to select or fine-tune to the exact blade speed required (from 400-1550 strokes per minute) for best results based on the type and thickness of material and type of blade being used.

The blade speed control knob ② is located on the top of the machine. (See Fig. 5)

- To increase blade speed, turn the control knob clockwise.
- To decrease blade speed turn the control knob counter clockwise.

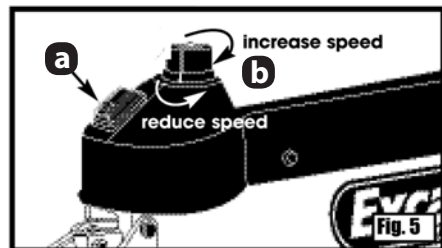
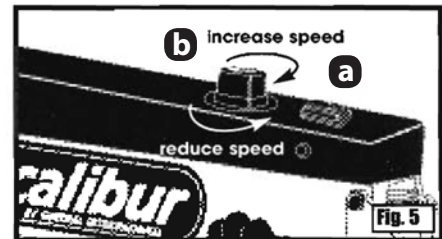

# Operating Instructions

Blade speed selection is subjective and is dependant on a variety of factors: type and thickness of material being cut, type of blade being used, feed rate, required finish quality as well as experience, personal preference and comfort level of the user. There are no hard and fast rules. Be patient – practice and experience will be your best teacher.

Here are some general guidelines to consider when selecting/adjusting blade speed:

- For best results and smoothest most efficient cutting, always select the highest blade speed that you are comfortable using based on your experience and skill level.
- Generally speaking, harder or denser workpiece material requires slower blade speeds.
- Slower speeds also work better with very thin blades, or when cutting most metals as well as for brittle or delicate material such as fine veneers.
- Some wood species will have a tendency to burn quicker at higher blade speeds. To avoid additional sanding later, reduce blade speed and feed speed at the first signs of burn marks on the workpiece.



## Adjusting the Blower

The EX-21 EX-30 is equipped with a built-in blower to help clear cutting dust from the workpiece surface in front of the blade and on any reference lines. Adjust the blower tube **a** as needed to point the nozzle at the blade to set it at a comfortable distance so as not to obstruct your hand movement as you work. (See Fig. 6)

## Workpiece Hold-Down

The workpiece hold-down **b** (See Fig. 6) can be adjusted to assist in preventing the blade from lifting the workpiece up from the table during the cut. Loosen the thumbscrew **c** to set the height to your convenience based on the thickness of the workpiece. Before cutting, test to make sure that the hold-down is not adjusted too tightly to the workpiece or that it obstructs the movement of the workpiece.

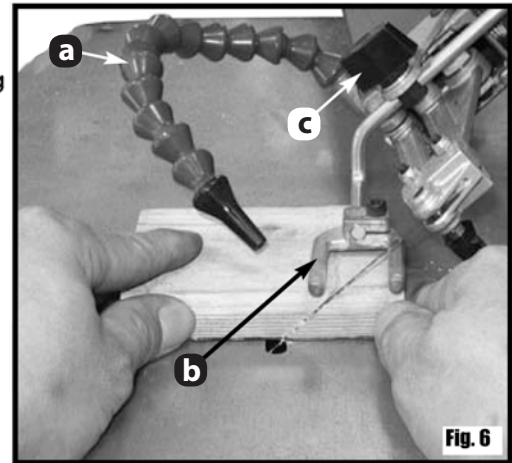

## Adjusting the Oscillation (Front to Back)

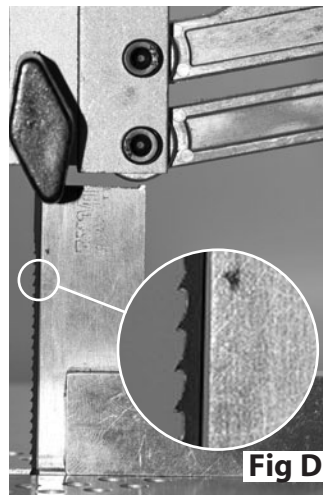
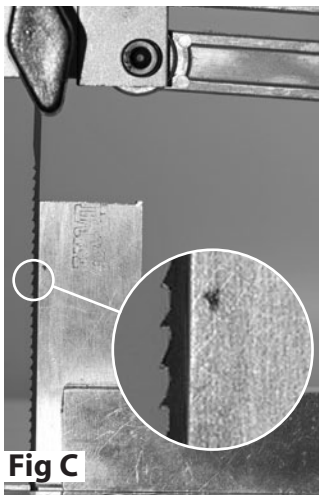

Place a 90° square up against the blade, the blade movement can be set between course and fine for different cutting tasks, this can be adjusted by rotating the motor within its' mounts. Loosen the motor mounting cap head bolts, see figs A enough to be able to rotate the motor (this can be quite stiff to turn), start the machine and run at approximately 1/4 speed. By rotating the motor, see fig B and carefully observing the blade you will be able to see the blade changing its setting. The finest setting is where the blade moves vertically with the least amount of movement, see fig C backward and forwards horizontally. This should also be where the machine vibrates the least. When you have the setting where you wish it to be, tighten the motor mounting bolts.

## Top & Bottom Blade holder Alignment

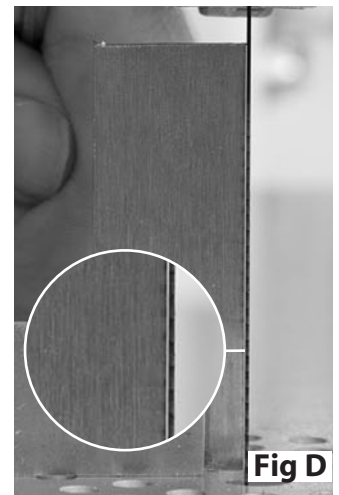
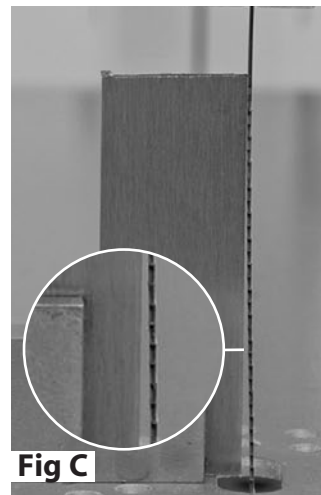
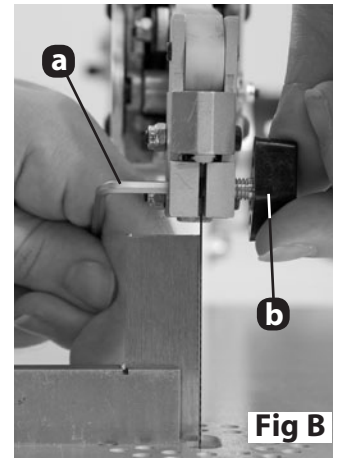
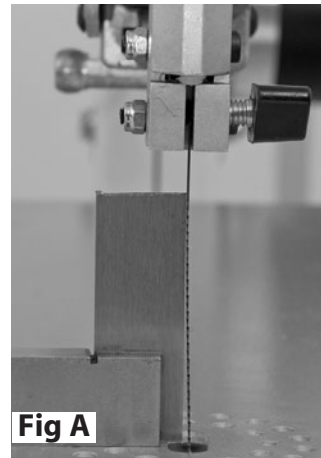

**If the blade is out of alignment please follow the procedures below for adjusting the top and bottom blade holders:**

Place a 90° square up against the blade, see fig A. Using a 4mm Hex key **(a)** adjust the grub screw and butterfly nut **(b)**, see fig B, until the blade is parallel with the square. (See figs C and D).

# Operating Instructions

## **Basic 90° straight or curved cuts**

All cuts made with the blade at 90° to the table follow the same basic principals. Start by marking or transferring your pattern or reference lines onto your workpiece.

**Note: The EX-30 has a 30" throat that allow for a workpiece of up to 30" of clearance to swing completely around without hitting the back of the saw. If necessary, rough-cut the workpiece down to a workable size before starting intricate work on the scroll saw. The above note applies also to the EX-16 (16") and EX-21 (21") scroll saws.**

1. With the saw turned off and unplugged, install the appropriate blade for the type of material to be cut and the type of cut to be made (Refer to the section "Choosing and Installing a Saw Blade" on page 9).
2. Adjust the workpiece hold-down and the blower nozzle to your liking.
3. Turn on the saw and set the speed controller to the desired blade speed.
4. With your fingers holding the piece firm to the table, and using your thumbs for directional control, (See Fig #7 & 8) feed the workpiece into the blade using steady, even pressure.
5. Make sure that the blade is cutting on the waste side of your reference line and adjust feed direction slightly as needed to compensate for blade drift.

**Cutting Tips: To stay in control on tight curve cuts, slow down your feed rate as needed to allow the blade teeth time to make the cut. Avoid coming to a complete stop whenever possible as this can leave burn marks on the workpiece and also makes it more difficult to get the piece re-started and moving through the cut again. Avoid forcing through a curve cut as this can cause the blade to twist and cut off-track or may even cause the blade to break.**

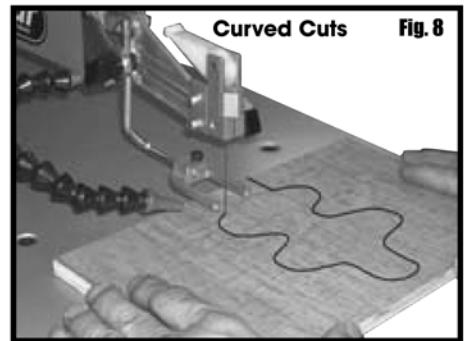
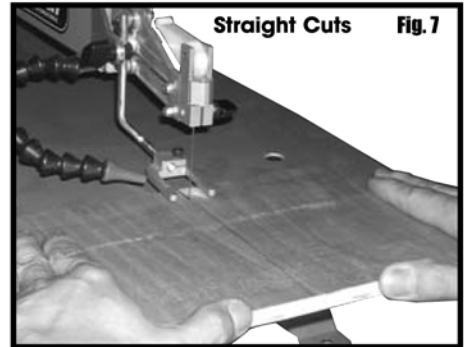

## **Fret Cutting**

Fret or inside cutting is an operation that can only be performed on a scroll saw. Fret cutting involves drilling a small guide or pilot hole through the interior of your pattern on the workpiece, then disconnecting one end of the blade which is fitted through the guide hole and re-connected; essentially using this guide hole as the starting point to cut out the piece from within. A typical example of fret cutting would be removing the center portion of lettering. (See Fig. 9)

The EX-21 EX-30 is a great tool for fret cutting because, unlike most scroll saws it allows you to raise the upper arm with the blade attached, line up the guide hole in your workpiece with the hole in the table and then lower the arm while guiding the blade through the hole from above (see step by step instructions below). This can be a very useful time saving feature, particularly for intricate or complex fret designs that can involve dozens or even hundreds of holes.

**Note: The upper arm locks in place in the raised position for easier insertion of the blade through the hole in the workpiece and for easier blade changes.**

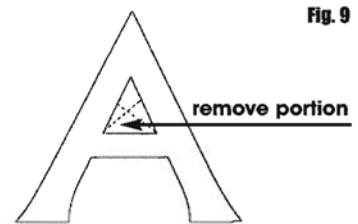

1. With the saw turned off and unplugged, install the appropriate blade for the type of material to be cut and the type of cut to be made (Refer to the section "Choosing and Installing a Saw Blade" on page 9 of this manual).
2. With your pattern or design transferred onto the workpiece, drill a guide hole in the inside waste portion of the workpiece. (See Fig. 10) Make sure that the hole is large enough for the blade to fit through.

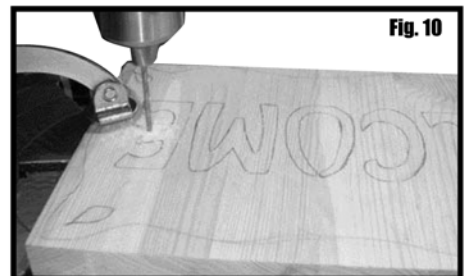

**Helpful hints on drilling guide holes: If multiple fret cuts are required on the same workpiece, drill all of your required guide holes before taking the workpiece to the scroll saw. This will keep you from going back and forth from the saw to the drill press.**

**To prolong blade life by limiting unnecessary cutting, drill your guide holes as close as possible to your reference lines. (See Fig. 11)**





3. Release tension on the blade by flipping the blade tension lever forward.
4. Loosen the thumbscrew on the lower blade mount, located under the table, to release the blade from the mount.
5. Raise the upper arm assembly which will lift the blade up through the hole and above the table.
6. Position the workpiece on the table so that the guide hole lines up with the hole in the table.
7. Lower the arm assembly with one hand while guiding the blade through the hole in the workpiece and table.
8. Re-install the bottom end of the blade in the lower blade mount and tighten the thumbscrew to secure the blade in the lower blade mount.
9. Flip back the blade tension lever to re-tension the blade and test the blade tension as described in "Installing or Changing Blades" section of this manual.
10. To begin cutting follow the same steps as described in "Basic 90° straight or curved cuts" section on page 9 of this manual.



To reduce the risk of injury, always turn off the saw and wait for the blade to come to a complete stop before reaching in to remove waste material from a fret cut.

## Angle or Bevel Cutting

One of the unique features of the EX-16 EX-21 EX-30 Scroll Saw is the ability to tilt the head of the saw in order to make angle or bevel cuts. The table and the workpiece always stay horizontal (parallel to the floor) while the blade tilts, keeping your hands in the same comfortable cutting position as they would normally be for regular right angle cuts. Because you are not fighting gravity or working with your hands or wrists bent in awkward positions, it can be a huge advantage and makes it easier and safer to make accurate bevel cuts.

The blade tilt controls are located under the table at the front saw. (See Fig. 12)

To tilt the blade for bevel cutting:

1. Release the locking lever **a** by turning counter-clockwise.
2. Turn the tilting handle **c** left or right to set the blade to the desired angle.

**Note:** Push in and hold the spring loaded indexing pin **b** to locate the following common angles: 90°, 45°, 30° & 22.5° both left and right.

**When tilting the blade to the left at extreme angles, it may be necessary to remove and reverse the lower blade mount thumbscrew assembly in order to maximize clearance under the table. (Fig. 13 shows the lower blade mount in default position and Fig. 14 shows it reversed).**

**To avoid kinking or damaging the blade in the holder, when making adjustments make sure the set screw **d** (opposite the thumbscrew **e**) is threaded in to the holder to protrude slightly beyond the blade slot **f**. (See Fig. 15)**

3. Tighten the locking lever **a** to secure the blade at the desired angle.
4. To begin cutting follow the same steps as described in "Basic 90° straight or curved cuts" section on page 11 of this manual. Fig. 16 shows the scroll saw in position for bevel cutting.

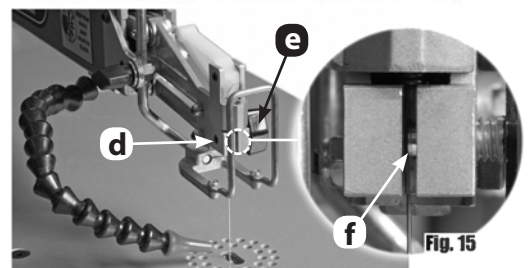
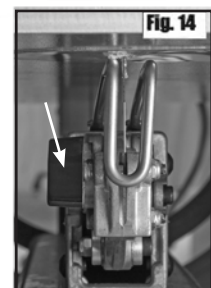
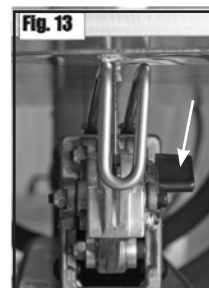
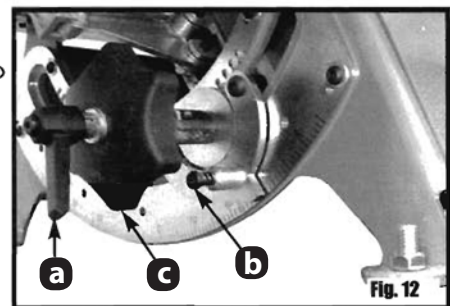

To reduce the risk of injury, always turn off the saw and wait for the blade to come to a complete stop before reaching in to remove waste material.

# Maintenance, Adjustments & Servicing

## Handling

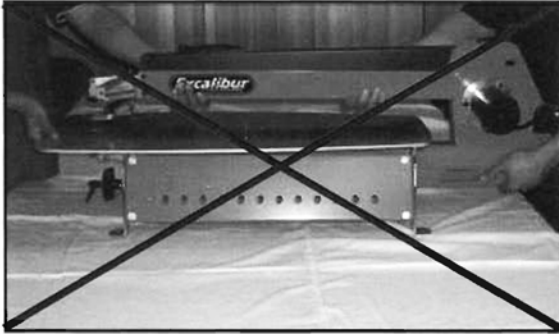

Never lift the saw by the upper arm assembly as this will result in damage to the drivetrain.

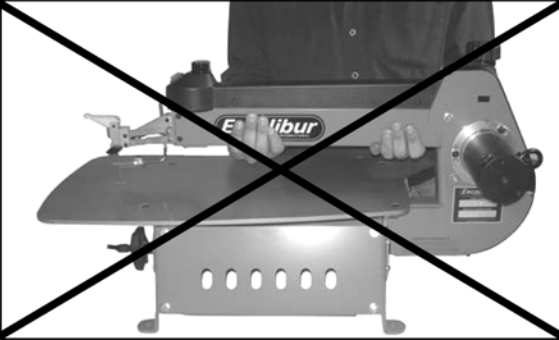

Never lift the saw by the upper arm assembly as this will result in damage to the drivetrain.

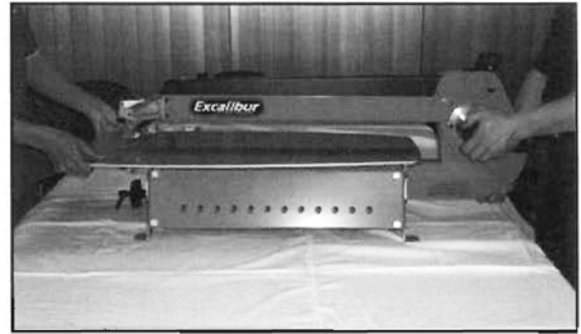

Rather lift the saw by the front of the table and by the motor.

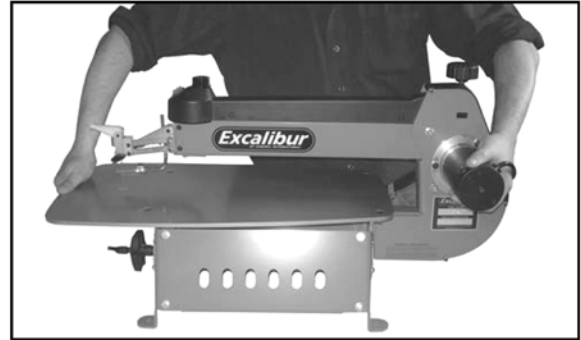

Rather lift the saw by the front of the table and by the motor.

## Maintenance

- Always release tension on the blade when the saw is not in use.
- Clean the saw regularly with a soft bristle brush or by vacuuming to keep cutting dust from accumulating.
- An occasional application of a light dab of grease on the front and rear trunnions (See Fig. 17) will keep the tilting mechanism working smoothly. If you find the tilting mechanism becoming more difficult to operate, thoroughly wipe off any built-up cutting dust on the trunnions and re-apply a little grease.
- The bearings in the drive mechanism are sealed and permanently lubricated and do not need to be oiled or greased.

## Squaring the blade to the table

Depending on frequency of use and how much the tilting mechanism is used, normal wear will over time cause the blade to come slightly out of alignment with the table. Periodically check the blade is square with the table. When needed, adjust as described in the following steps to re-align the blade square to the table.

1. Turn off and unplug the saw.
2. Using the blade tilt controls at the front of the saw, set the blade angle to read 0 - which is 90° vertical to the table.
3. Set a machinists square on the table and against the blade to verify the blade angle. (See Fig. 18)
4. If the blade angle requires adjustment loosen the 4 bolts in the front trunnion **a** as well as the 4 bolts on the rear trunnions **b**.
5. By hand, move the entire head to bring the blade square to the table.
6. With the blade square to the table hold the head in position and re-tighten the bolts on the front and rear trunnions.

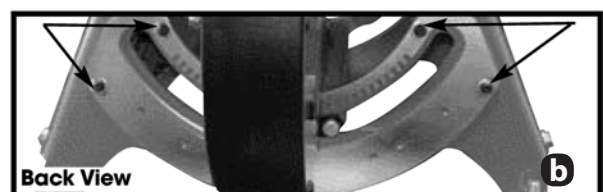
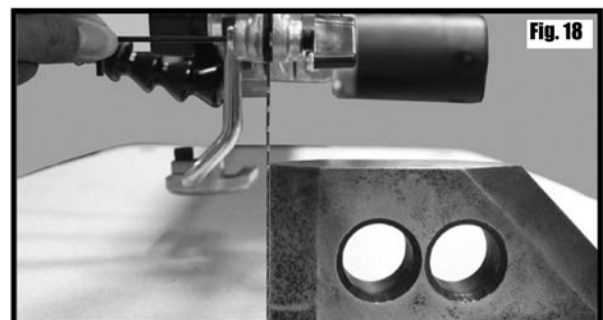
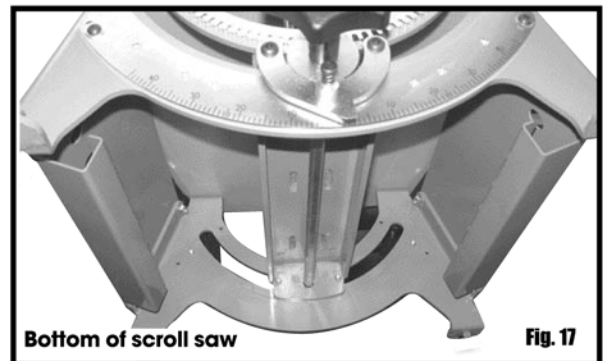

## Upper arm tension adjustment

Over time and with normal wear, the upper arm tension will require adjustment to hold the arm in the raised position.

To adjust the upper arm tension:

1. Loosen the lock nut. (See Fig. 19)
2. Adjust the tension screw until the arm stays in raised position.
3. Re-tighten the lock nut.

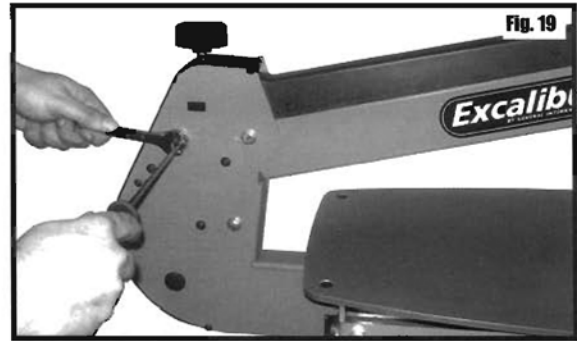

## Changing the Fuse

The Excalibur scroll saws takes a 5 Amp 20 x 5mm glass fuse, follow the instructions below on how to change the fuse.



1. Unplug the scroll saw from the mains
2. Using a screwdriver un-clip the fuse compartment assembly, situated below the power connector



3. Remove the fuse from it's compartment and replace it with a new one
4. Re-insert the fuse assembly until it clips home

## Specifications

Code	505079	505078	505077
Model	EX-16	EX-21	EX-30
Rating	Trade	Trade	Trade
Power	230V 50Hz 320W	230V 50Hz 320W	230V 50Hz 320W
Throat	406mm	535mm	762mm
Stroke	18mm	18mm	18mm
Cuts per Minute	400 -1,400	400 -1,550	400-1,550
Max Depth of Cut	51mm	51mm	51mm
Table Size	305 x 470mm	345 x 597mm	358 x 825mm
Arm Tilt	Left 35° Right -45°	Left 35° Right -45°	Left 35° Right -45°
Overall L x W x H	686 x 380 x 432mm	812 x 380 x 387mm	1,100 x 394 x 387mm
Weight	24.5kg	29.5kg	52kg



# Optional Accessories

## Foot Switch with Trailing Plug & Socket

These two foot-operated safety switches are equipped with trailing plugs and sockets and can easily be inserted between the mains supply and any machine fitted with a no volt release switch, such as a drill, bandsaw or lathe.

Operation of the switch interrupts the supply to the solenoid and the machine is stopped; re-starting can only be achieved by operating the NVR switch on the machine, creating an excellent safety measure in those situations where safety is of paramount.



## Stand Assembly

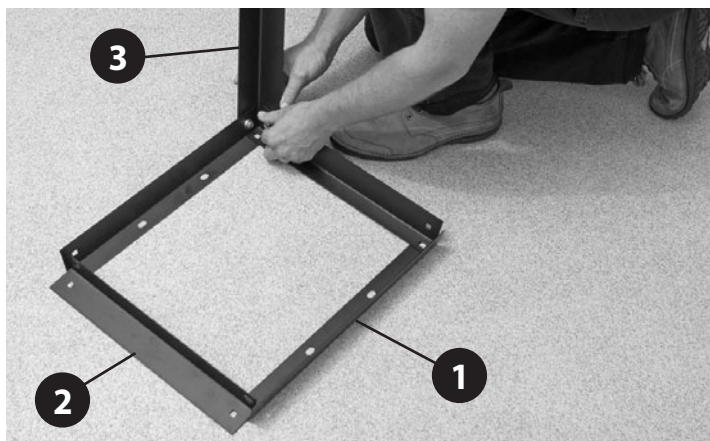
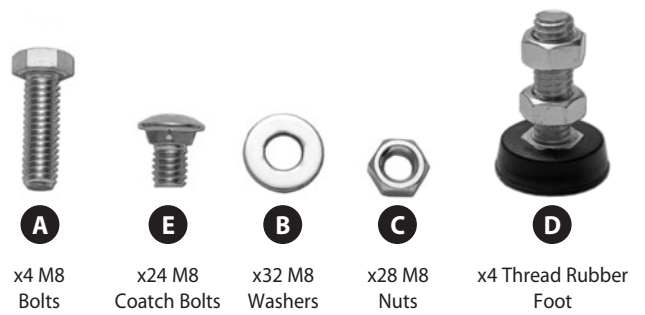
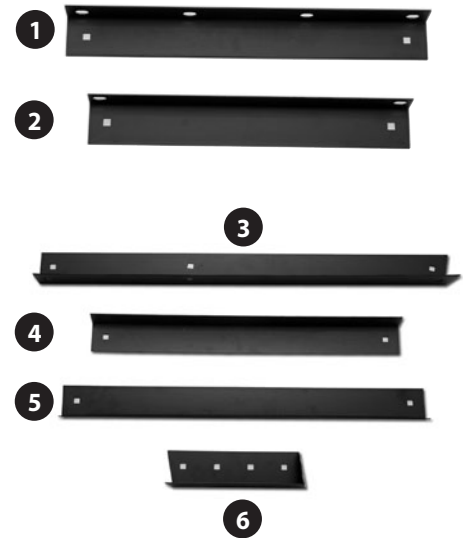
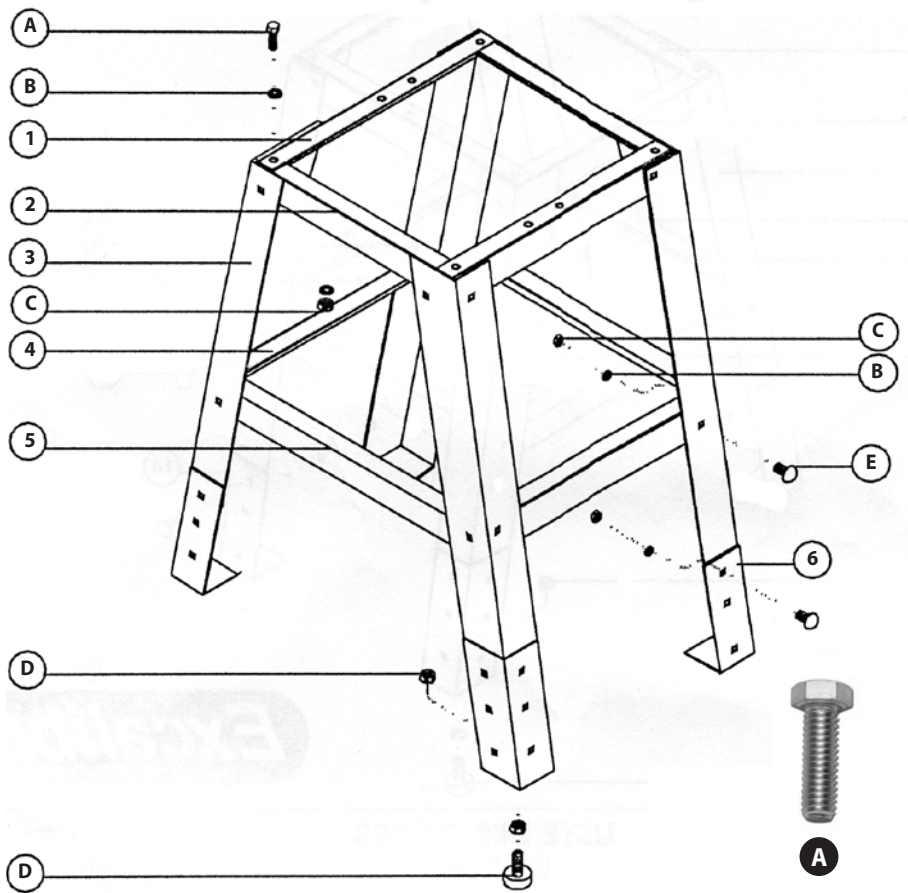

Step 1

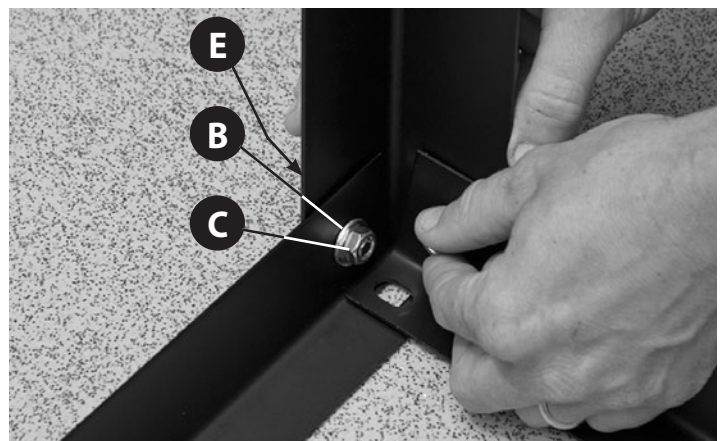

Step 2



# Stand Assembly

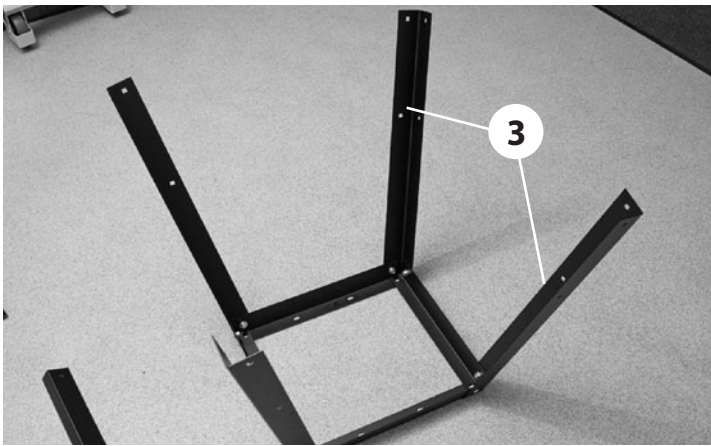

Step 3

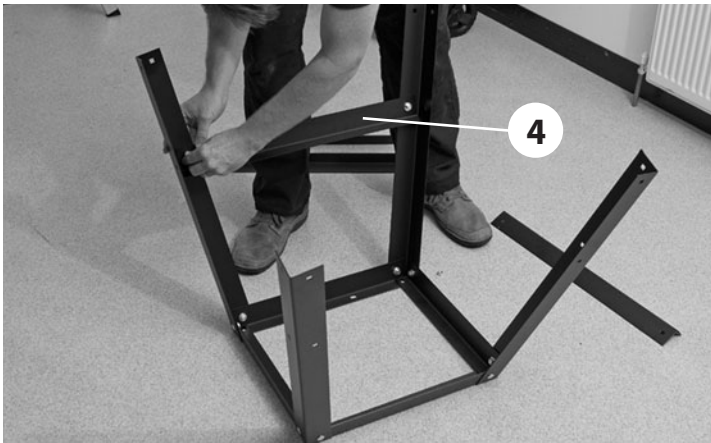

Step 4

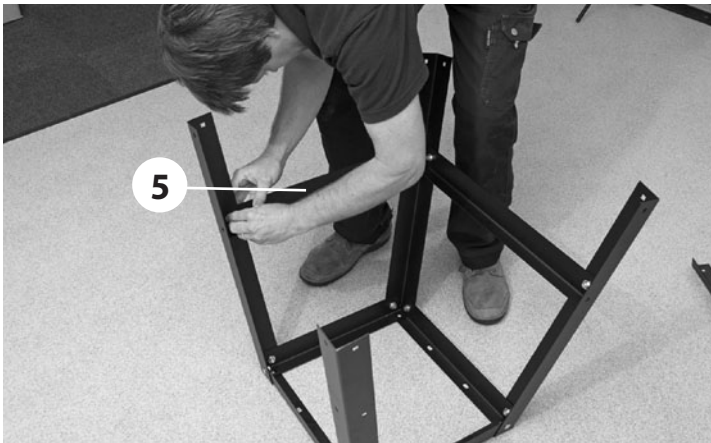

Step 5

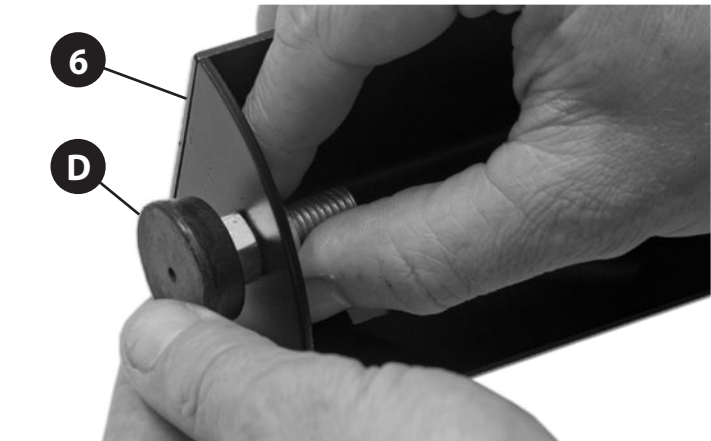

Step 6

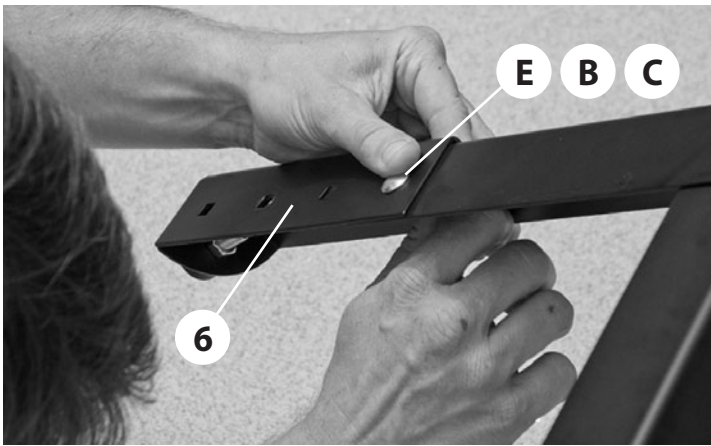

Step 7

Use the holes in the bracket (6) to adjust the the stand height



Stand assembled

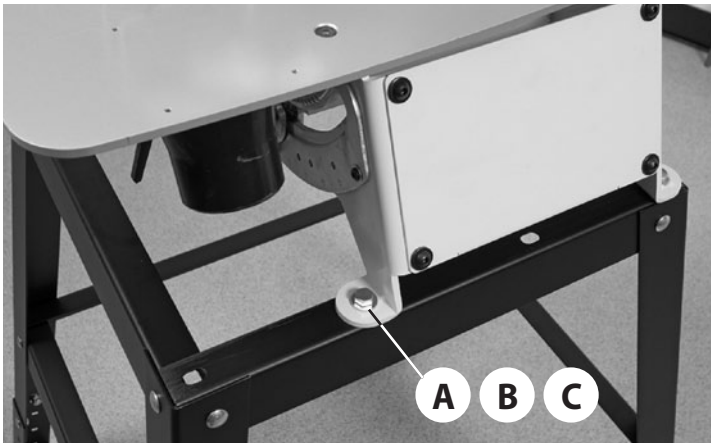

Lower the scroll saw on top of the stand and lineup the holes, secure using the four bolts (A) washers (B) and Nuts (C)



# EX-16 Parts Breakdown (A)

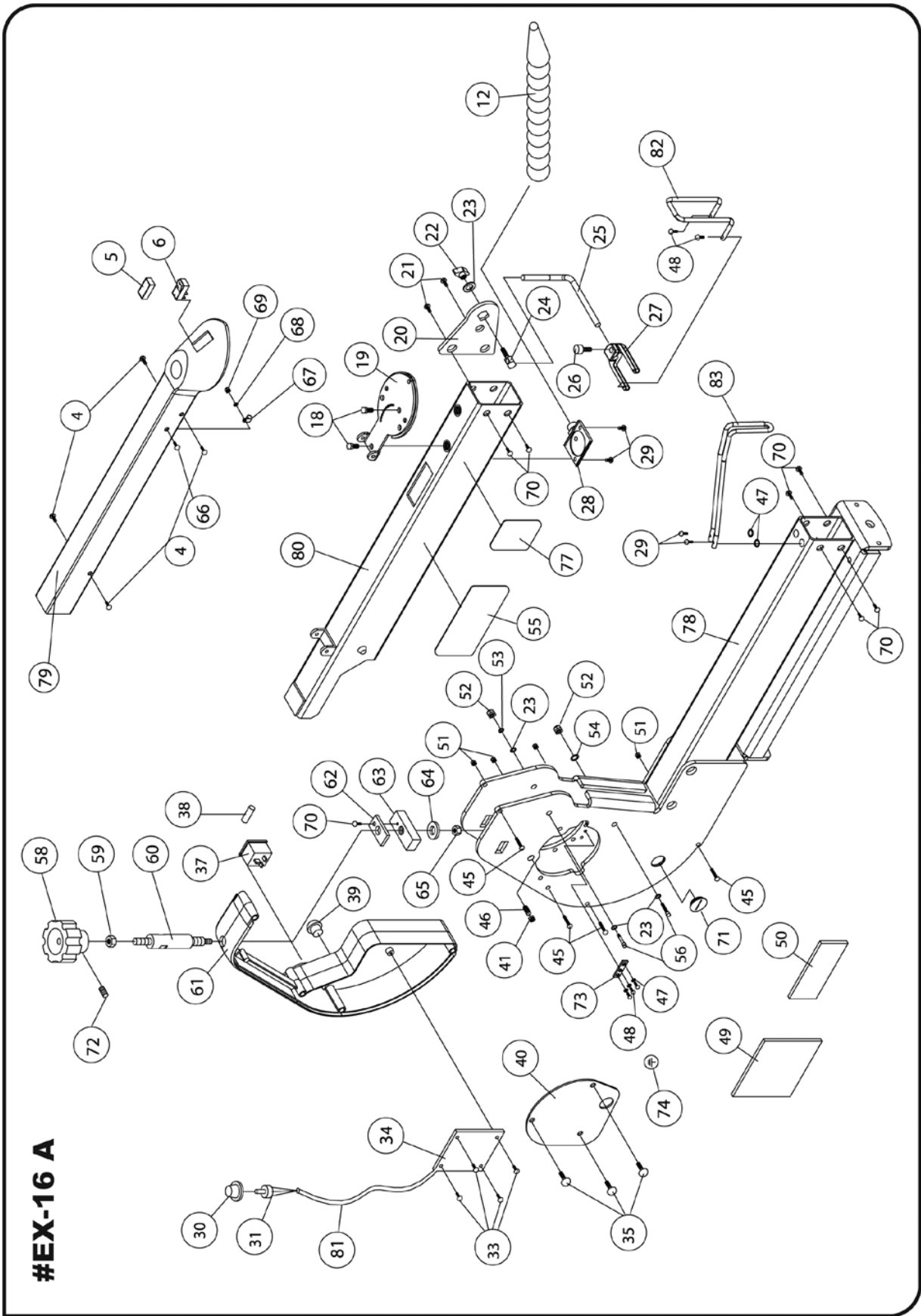

# EX-16 Parts List (A)

Part No	Description	Specification	Qty
EX16-A04	ALLEN SCREW	#10-32X1/4"	4
EX16-A05	SWITCH COVER		1
EX16-A06	SWITCH		1
EX16-A12	AIR NOZZLE		1
EX16-A18	BOLT	1/4-20 X 1/2"	2
EX16-A19	UPPER & LOWER TENSION PLATE		1
EX16-A20	HOLD DOWN MOUNT PLATE		1
EX16-A21	ALLEN SCREW	#10-32X3/8"	2
EX16-A22	HOLD DOWN CLAMP KNOB		1
EX16-A23	WASHER	1/4X16X1.8"	4
EX16-A24	HOLD DOWN CLAMP SCREW		1
EX16-A25	HOLD DOWN BAR		1
EX16-A26	CAP SCREW	#10-32X1/2"	1
EX16-A27	HOLD DOWN FORKS		1
EX16-A28	DUST BLOWER		1
EX16-A29	TAP SCREW	#8-32UNF 3/8"	4
EX16-A30	VR KNOB		1
EX16-A31	VR		1
EX16-A33	SCREW	M4X8	4
EX16-A34	MOTOR CONTROL SET		1
EX16-A35	ALLEN SCREW	1/4-20X1/2"	3
EX16-A37	LINE CORD SOCKET		1
EX16-A38	FUSE		1
EX16-A39	STRAIN RELIEF		1
EX16-A40	GEAR COVER		1
EX16-A41	NUT	3/8 X T5.5	1
EX16-A45	ALLEN SCREW	#10-32X2-1/4"	4
EX16-A46	SCREW	3/8"X 5/8"	1
EX16-A47	WASHER	#8	5
EX16-A48	SCREW	#8-32X1/4"	5
EX16-A49	MOTOR LABEL		1

Part No	Description	Specification	Qty
EX16-A50	WARNING LABEL		1
EX16-A51	NYLON NUT	#10-32	4
EX16-A52	NYLON NUT	1/4-20UNC	2
EX16-A53	LOCK WASHER	1/4"	1
EX16-A54	FLAT WASHER	1/4" (O.D.I.3)	1
EX16-A55	LABEL		2
EX16-A56	SCREW	1/4X2-1/2"	2
EX16-A58	KNOB		1
EX16-A59	NUT	M6	1
EX16-A60	ADJUSTING LEVER		1
EX16-A61	CONTROL BOX		1
EX16-A62	CROSS BLOCK RETAINER		1
EX16-A63	HOUSING CROSS BLOCK		1
EX16-A64	FLAT WASHER	M6X 16X2	1
EX16-A65	NYLON NUT	M6	1
EX16-A66	ALLEN SCREW		1
EX16-A67	R FASTENER		1
EX16-A68	WASHER		1
EX16-A69	NYLON NUT		1
EX16-A70	ALLEN SCREW		7
EX16-A71	BUTTON		1
EX16-A72	SET SCREW		1
EX16-A73	GROUND PLATE		1
EX16-A74	GROUND LABEL		1
EX16-A77	LABEL		1
EX16-A78	MAIN BODY		1
EX16-A79	TOP COVER		1
EX16-A80	UPPER ARM		1
EX16-A81	CONTROL CABLE		1
EX16-A82	UPPER BLADE GUARD		1
EX16-A83	LOWER BLADE GUARD		1

# EX-16 Parts Breakdown (B)

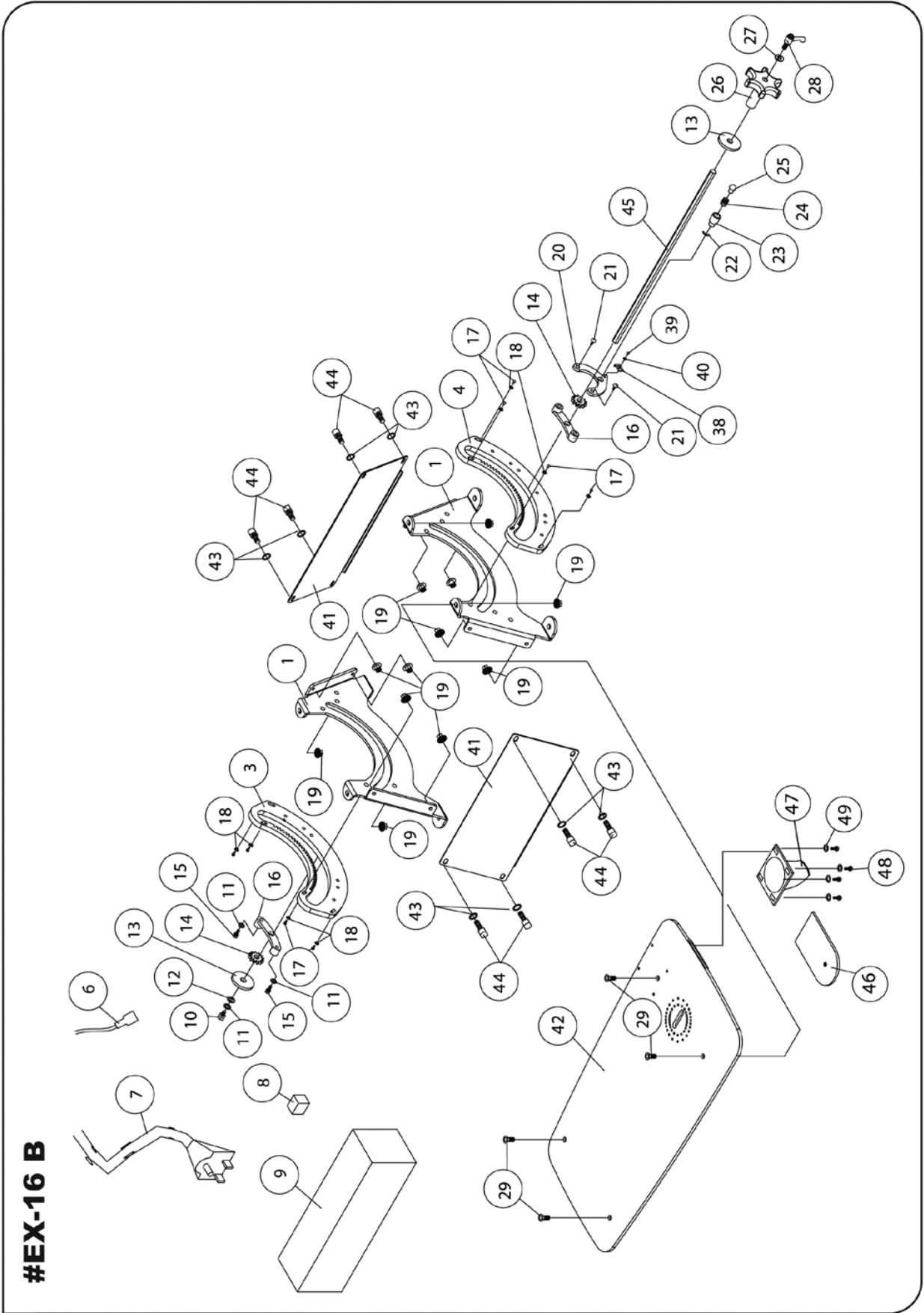



## EX-16 Parts List (B)

Part No	Description	Specification	Qty
EX16-B01	TRUNNION		2
EX16-B03	REAR TRUNNION PLATE		1
EX16-B04	FRONT TRUNNION PLATE		1
EX16-B06	GROUND JUMPER		1
EX16-B07	POWER CORD	CSA	1
EX16-B08	SPONG BLOCK		1
EX16-B09	POLYFOAM		1
EX16-B10	SCREW	1/4-20UNCX 1/2	1
EX16-B11	LOCK WASHER	1-Apr	3
EX16-B12	WASHER	1-Apr	9
EX16-B13	BLADE TILT WASHER		2
EX16-B14	BLADE TILT DRIVE GEAR		2
EX16-B15	SCREW	1/4-20UNCX 3/4	10
EX16-B16	ANGLE FOLLOWER		2
EX16-B17	SCREW	#10-32X5/16	8
EX16-B18	WASHER	#10X 12X1	8
EX16-B19	NUT	1/4-20UNC	12
EX16-B20	ANGLE INDICATOR		1
EX16-B21	ALLEN SCREW	1/4-20 X 1"	2
EX16-B22	E RING	ETW-3	1
EX16-B23	TILT DETENT BARREL		1
EX16-B24	SPRING		1
EX16-B25	DETENT PLUNGER		1
EX16-B26	TILT HANDLE		1
EX16-B27	WASHER	1/4X 16X3	1
EX16-B28	BLADE TILT LOCKING LEVER		1
EX16-B29	FLAT HEAD SCREW	1/4-20X3/4	4
EX16-B38	POINTER		1
EX16-B39	ROUND HEAD SCREW	M4 X 6MM	1
EX16-B40	WASHER	M4	1
EX16-B41	SIDE PANEL		2
EX16-B42	TABLE		1
EX16-B43	WASHER	1/4.	8
EX16-B44	ALLEN SCREW	1/4-20UNCX 3/4	8
EX16-B45	TILT LOCK DRAW ROD		1
EX16-B46	COVER		1
EX16-B47	DUST CHUT		1
EX16-B48	ROUND HEAD SCREW	#8-32unc-5/16	4
EX16-B49	WASHER	#8-32unc	4

# EX-21 Parts Breakdown (A)

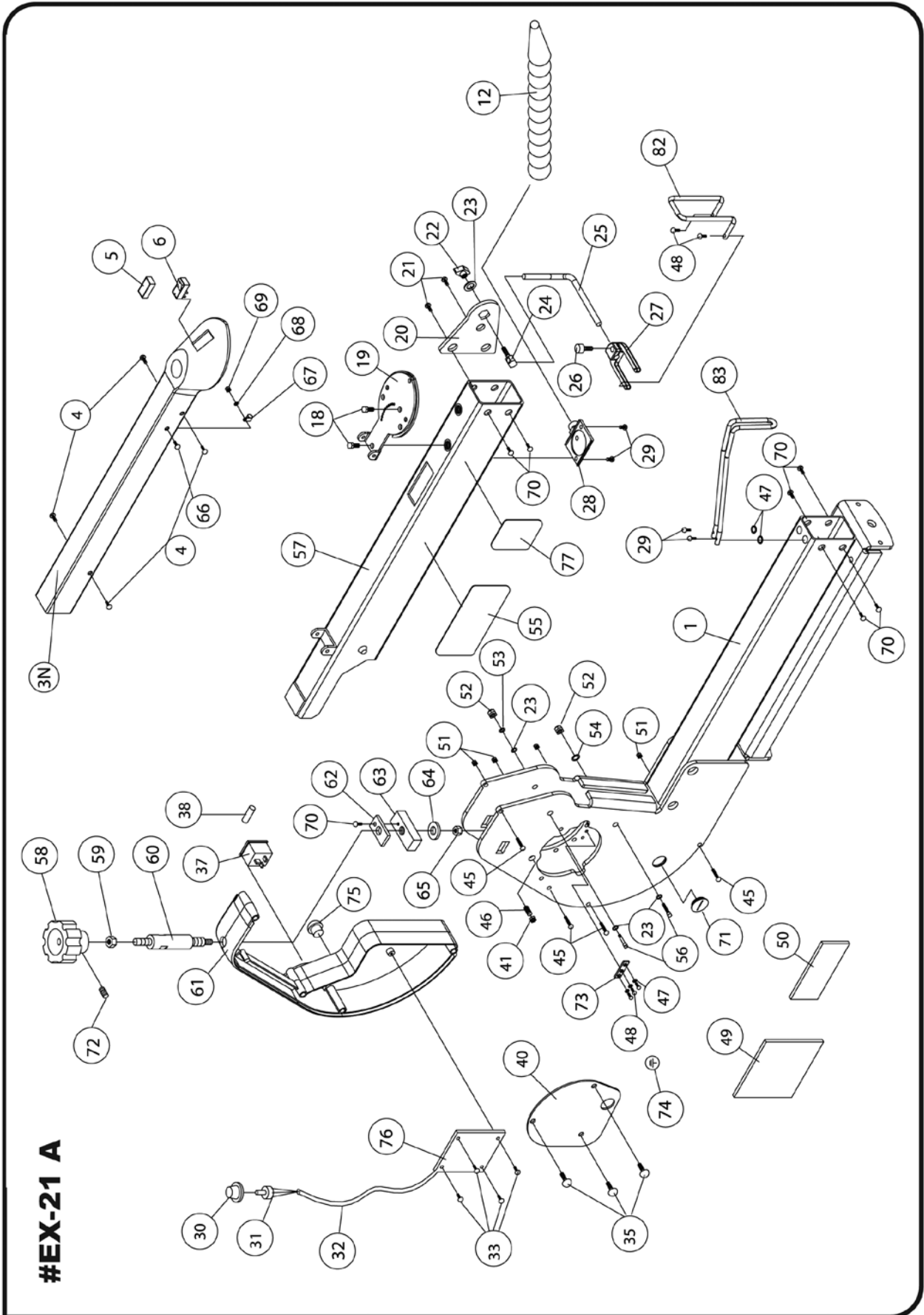

#EX-21 A

## EX-21 Parts List (A)

Part No	Description	Specification	Qty
EX21-A01	MAIN BODY		1
EX21-A03N	TOP COVER		1
EX21-A04	ALLEN SCREW	#10-32X 1/4"	4
EX21-A05	SWITCH COVER		1
EX21-A06	SWITCH		1
EX21-A12	AIR NOZZLE		1
EX21-A18	BOLT	1/4-20 X 1/2"	2
EX21-A19	UPPER & LOWER TENSION PLATE		1
EX21-A20	HOLD DOWN MOUNT PLATE		1
EX21-A21	ALLEN SCREW	#10-32X3/8"	2
EX21-A22	HOLD DOWN CLAMP KNOB		1
EX21-A23	WASHER	1/4X16X1.8"	4
EX21-A24	HOLD DOWN CLAMP SCREW		1
EX21-A25	HOLD DOWN BAR		1
EX21-A26	CAP SCREW	#10-32X 1/2"	1
EX21-A27	HOLD DOWN FORKS		1
EX21-A28	DUST BLOWER		1
EX21-A29	TAP SCREW	#M2UNF 3/8"	4
EX21-A30	VR KNOB		1
EX21-A31	VR		1
EX21-A32	CONTROL CABLE		1
EX21-A33	SCREW	M4X8	4
EX21-A35	ALLEN SCREW	1/4-20 X 1/2"	3
EX21-A37	LINE CORD SOCKET		1
EX21-A38	FUSE	5AMP	1
EX21-A40	GEAR COVER		1
EX21-A41	NUT	3/8 X T5.5	1
EX21-A45	ALLEN SCREW	#10-32X2-1/4"	4
EX21-A46	SCREW	3/8"X 5/8"	1
EX21-A47	WASHER	#8	5
EX21-A48	SCREW	#8-32 X 1/4"	5

Part No	Description	Specification	Qty
EX21-A49	MOTOR LABEL		1
EX21-A50	WARNING LABEL		1
EX11-A51	NYLON NUT	#10-32	4
EX21-A52	NYLON NUT	1/4-20UNC	2
EX21-A53	LOCK WASHER	1/4"	1
EX21-A54	FLAT WASHER	1/4"(O.D.13)	1
EX21-A55	LABEL		2
EX21-A56	SCREW	1/4X2-1/2"	2
EX21-A57	UPPER ARM		1
EX21-A58	KNOB		1
EX21-A59	NUT	M6	1
EX21-A60	ADJUSTING LEVER		1
EX21-A61	CONTROL BOX		1
EX21-A62	CROSS BLOCK RETAINER		1
EX21-A63	HOUSING CROSS BLOCK		1
EX21-A64	FLAT WASHER	M6X 16X2	1
EX21-A65	NYLON NUT	M6	1
EX21-A66	ALLEN SCREW		1
EX21-A67	R FASTENER		1
EX21-A68	WASHER		1
EX21-A69	NYLON NUT		1
EX21-A70	ALLEN SCREW		7
EX21-A71	BUTTON		1
EX21-A72	SET SCREW		1
EX21-A73	GROUND PLATE		1
EX21-A74	GROUND LABEL		1
EX21-A75	STRAIN RELIEF		1
EX21-A76	MOTOR CONTROL SET		1
EX21-A77	LABEL		1
EX21-A82	UPPER BLADE GUARD		1
EX21-A83	LOWER BLADE GUARD		1



# EX-21 Parts Breakdown (B)

#EX-21 B

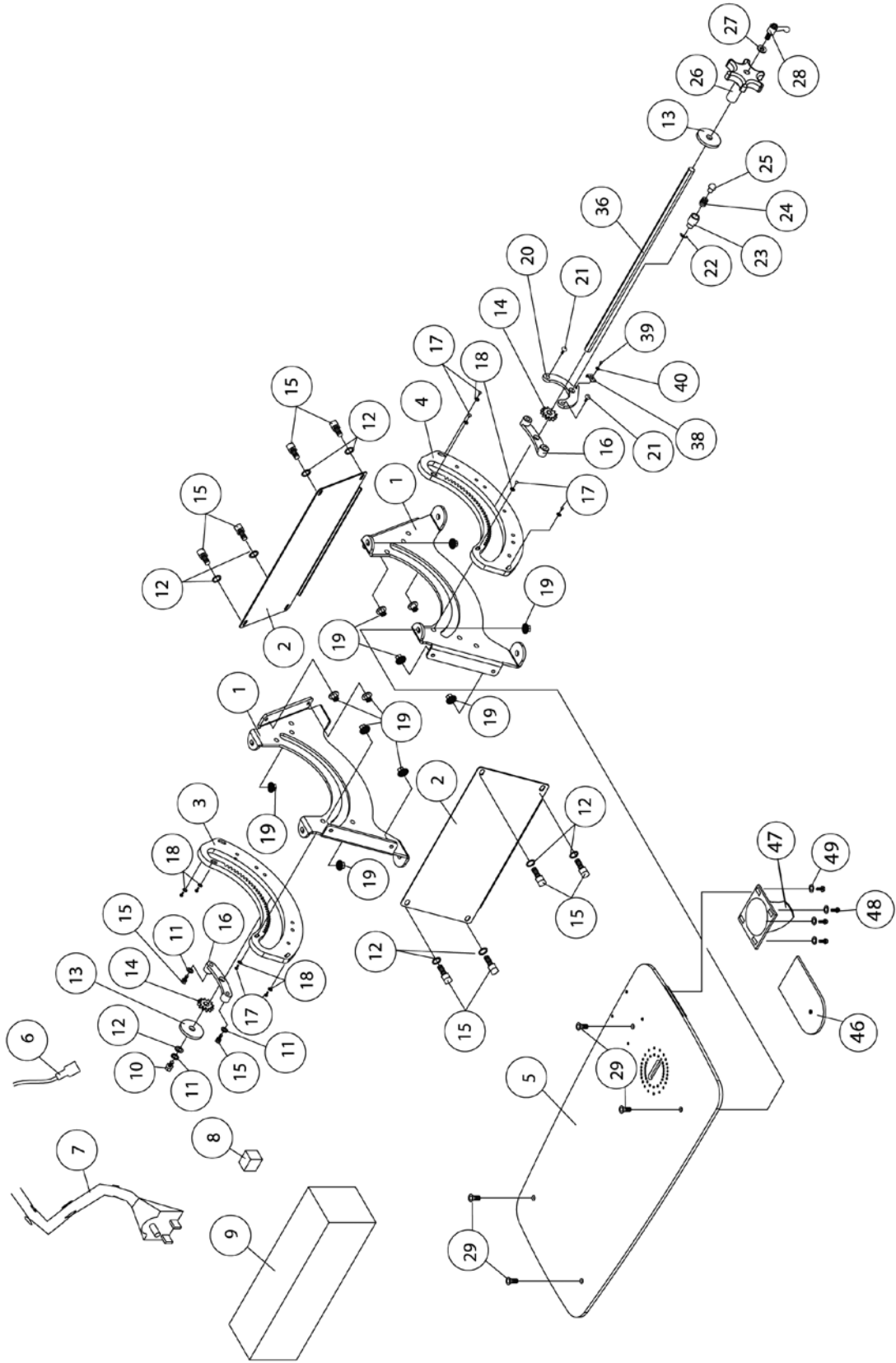

## EX-21 Parts List (B)

Part No	Description	Specification	Qty
EX21-B01	TRUNNION		2
EX21-B02	SIDE PANEL		2
EX21-B03	REAR TRUNNION PLATE		1
EX21-B04	FRONT TRUNNION PLATE		1
EX21-B05	TABLE		1
EX21-B06	GROUND JUMPER		1
EX21-B07	POWER CORD	CSA	1
EX21-B08	SPONG BLOCK		1
EX21-B09	POLYFOAM		1
EX21-B10	SCREW	1/4-20UNCX1/2	1
EX21-B11	LOCK WASHER	1-Apr	3
EX21-B12	WASHER	1-Apr	9
EX21-B13	BLADE TILT WASHER		2
EX21-B14	BLADE TILT DRIVE GEAR		2
EX21-B15	SCREW	1/4-20UNCX3/4	10
EX21-B16	ANGLE FOLLOWER		2
EX21-B17	SCREW	#10-32X5/16	8
EX21-B18	WASHER	#10X 12X 1	8
EX21-B19	NUT	1/4-20UNC	12
EX21-B20	ANGLE INDICATOR		1
EX21-B21	ALLEN SCREW	1/4-20 X 1"	2
EX21-B22	E RING	ETW-3	1
EX21-B23	TILT DETENT BARREL		1
EX21-B24	SPRING		1
EX21-B25	DETENT PLUNGER		1
EX21-B26	TILT HANDLE		1
EX21-B27	WASHER	1/4X16X3	1
EX21-B28	BLADE TILT LOCKING LEVER		1
EX21-B29	FLAT HEAD SCREW	12/6/201312/6/2013	4
EX21-B36	TILT LOCK DRAW ROD		1
EX21-B38	POINTER		1
EX21-B39	ROUND HEAD SCREW	M4 X 6MM	1
EX21-B40	WASHER	M4	1
EX21-B46	COVER		1
EX21-B47	DUST CHUT		1
EX21-B48	ROUND HEAD SCREW	#8-32unc-5/16	4
EX21-B49	WASHER	#8-32unc	4

# EX-30 Parts Breakdown (A)

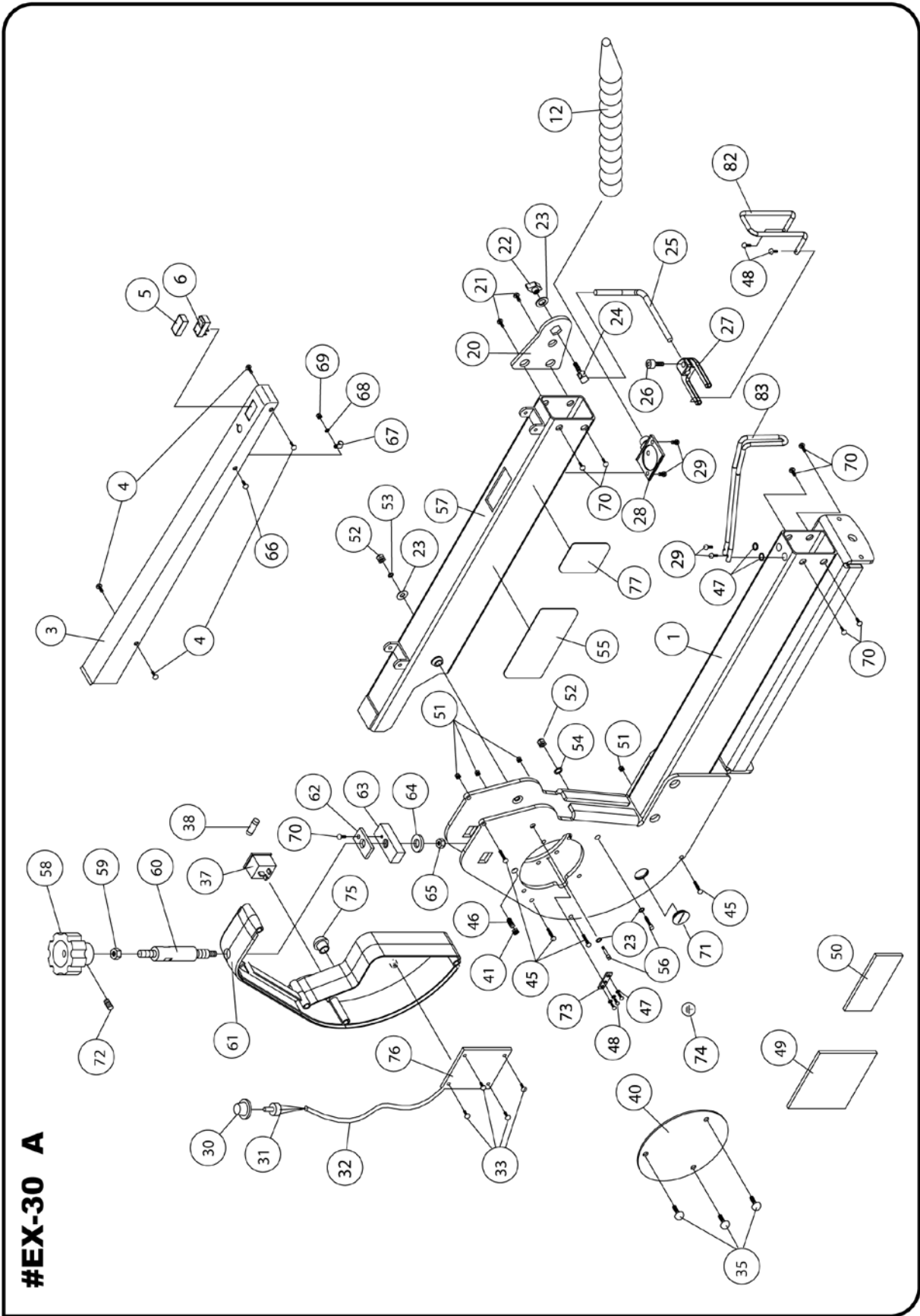

#EX-30 A



## EX-30 Parts List (A)

Part No	Description	Specification	Qty
EX30-A01	MAIN BODY		1
EX30-A03	TOP COVER		1
EX30-A04	ALLEN SCREW	#10-32 X 1/4"	4
EX30-A05	SWITCH COVER		1
EX30-A06	SWITCH		1
EX30-A12	AIR NOZZLE		1
EX30-A20	HOLD DOWN MOUNT PLATE		1
EX30-A21	ALLEN SCREW	#10-32X3/8"	2
EX30-A22	HOLD DOWN CLAMP KNOB		1
EX30-A23	WASHER	1/4X16X1.8"	4
EX30-A24	HOLD DOWN CLAMP SCREW		1
EX30-A25	HOLD DOWN BAR		1
EX30-A26	CAP SCREW	#10-32X 1/2"	1
EX30-A27	HOLD DOWN FORKS		1
EX30-A28	DUST BLOWER		1
EX30-A29	TAP SCREW	#8-32UNF 3/8"	4
EX30-A30	VR KNOB		1
EX30-A31	VR		1
EX30-A32	CONTROL CABLE		1
EX30-A33	SCREW	M4X8	4
EX30-A35	ALLEN SCREW	1/4-20X1/2"	3
EX30-A37	LINE CORD SOCKET		1
EX30-A38	FUSE		1
EX30-A40	GEAR COVER		1
EX30-A41	NUT	3/8 X T5.5	1
EX30-A45	ALLEN SCREW	#10-32X2-1/4"	4
EX30-A46	SCREW	3/8"X 5/8"	1
EX30-A47	WASHER	#8	5
EX30-A48	SCREW	#8-32 X 1/4"	5
EX30-A49	MOTOR LABEL		1

Part No	Description	Specification	Qty
EX30-A50	WARNING LABEL		1
EX30-A51	NYLON NUT	#10-32	4
EX30-A52	NYLON NUT	1/4-20UNC	2
EX30-A53	LOCK WASHER	1/4"	1
EX30-A54	FLAT WASHER	1/4"(O.D.I 3)	1
EX30-A55	LABEL		2
EX30-A56	SCREW	1/4X2-1/2"	2
EX30-A57	UPPER ARM		1
EX30-A58	KNOB		1
EX30-A59	NUT	M6	1
EX30-A60	ADJUSTING LEVER		1
EX30-A61	CONTROL BOX		1
EX30-A62	CROSS BLOCK RETAINER		1
EX30-A63	HOUSING CROSS BLOCK		1
EX30-A64	FLAT WASHER	M6X16X2	1
EX30-A65	NYLON NUT	M6	1
EX30-A66	ALLEN SCREW		1
EX30-A67	R FASTENER		1
EX30-A68	WASHER		1
EX30-A69	NYLON NUT		1
EX30-A70	ALLEN SCREW		7
EX30-A71	BUTTON		1
EX30-A72	SET SCREW		1
EX30-A73	GROUND PLATE		1
EX30-A74	GROUND LABEL		1
EX30-A75	STRAIN RELIEF		1
EX30-A76	MOTOR CONTROL SET		1
EX30-A77	LABEL		1
EX30-A82	UPPER BLADE GUARD		1
EX30-A83	LOWER BLADE GUARD		1

# EX-30 Parts Breakdown (B)

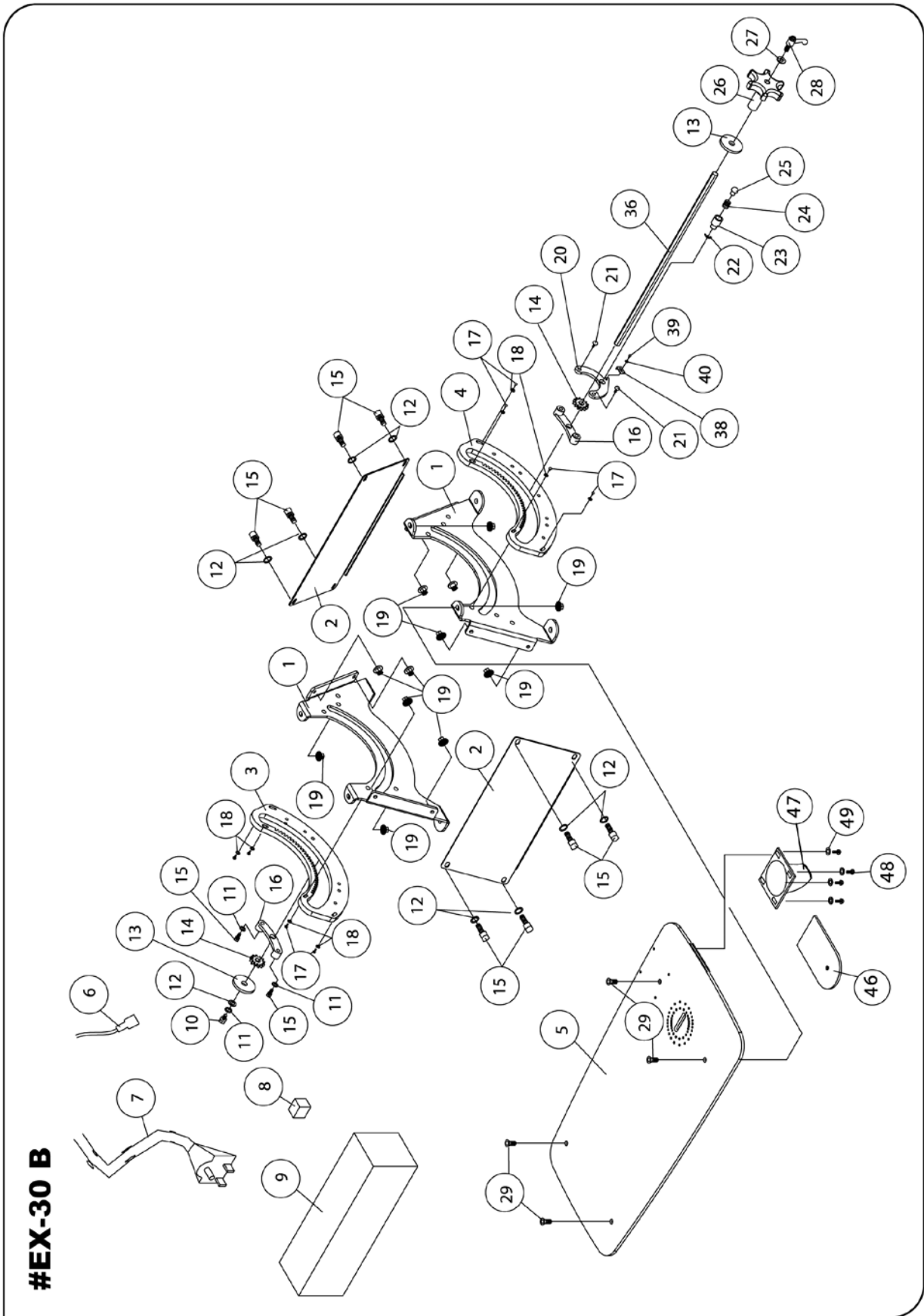

## EX-30 Parts List (B)

Part No	Description	Specification	Qty
EX30-B01	TRUNNION		2
EX30-B02	SIDE PANEL		2
EX30-B03	REAR TRUNNION PLATE		1
EX30-B04	FRONT TRUNNION PLATE		1
EX30-B05	TABLE		1
EX30-B06	GROUND JUMPER		1
EX30-B07	POWER CORD	CSA	1
EX30-B08	SPONG BLOCK		1
EX30-B09	POLYFOAM		1
EX30-B10	SCREW	1/4-20UNCX1/2	1
EX30-B11	LOCK WASHER	1-Apr	3
EX30-B12	WASHER	1-Apr	9
EX30-B13	BLADE TILT WASHER		2
EX30-B14	BLADE TILT DRIVE GEAR		2
EX30-B15	SCREW	1/4-20UNCX3/4	10
EX30-B16	ANGLE FOLLOWER		2
EX30-B17	SCREW	#10-32X5/16	8
EX30-B18	WASHER	#10X12X1	8
EX30-B19	NUT	1/4-20UNC	12
EX30-B20	ANGLE INDICATOR		1
EX30-B21	ALLEN SCREW	1/4-20 X 1"	2
EX30-B22	ERING	ETW-3	1
EX30-B23	TILT DETENT BARREL		1
EX30-B24	SPRING		1
EX30-B25	DETENT PLUNGER		1
EX30-B26	TILT HANDLE		1
EX30-B27	WASHER	1/4X16X3	1
EX30-B28	BLADE TILT LOCKING LEVER		1
EX30-B29	FLAT HEAD SCREW	1/4-20X3/4	4
EX30-B36	TILT LOCK DRAW ROD		1
EX30-B38	POINTER		1
EX30-B39	ROUND HEAD SCREW	M4 X 6MM	1
EX30-B40	WASHER	M4	1
EX30-B46	COVER		1
EX30-B47	DUST CHUT		1
EX30-B48	ROUND HEAD SCREW	#8-32unc-5/16	4
EX30-B49	WASHER	#8-32unc	4



# EX-16, EX-21 EX-30 Drive Assembly Breakdown/List (C)

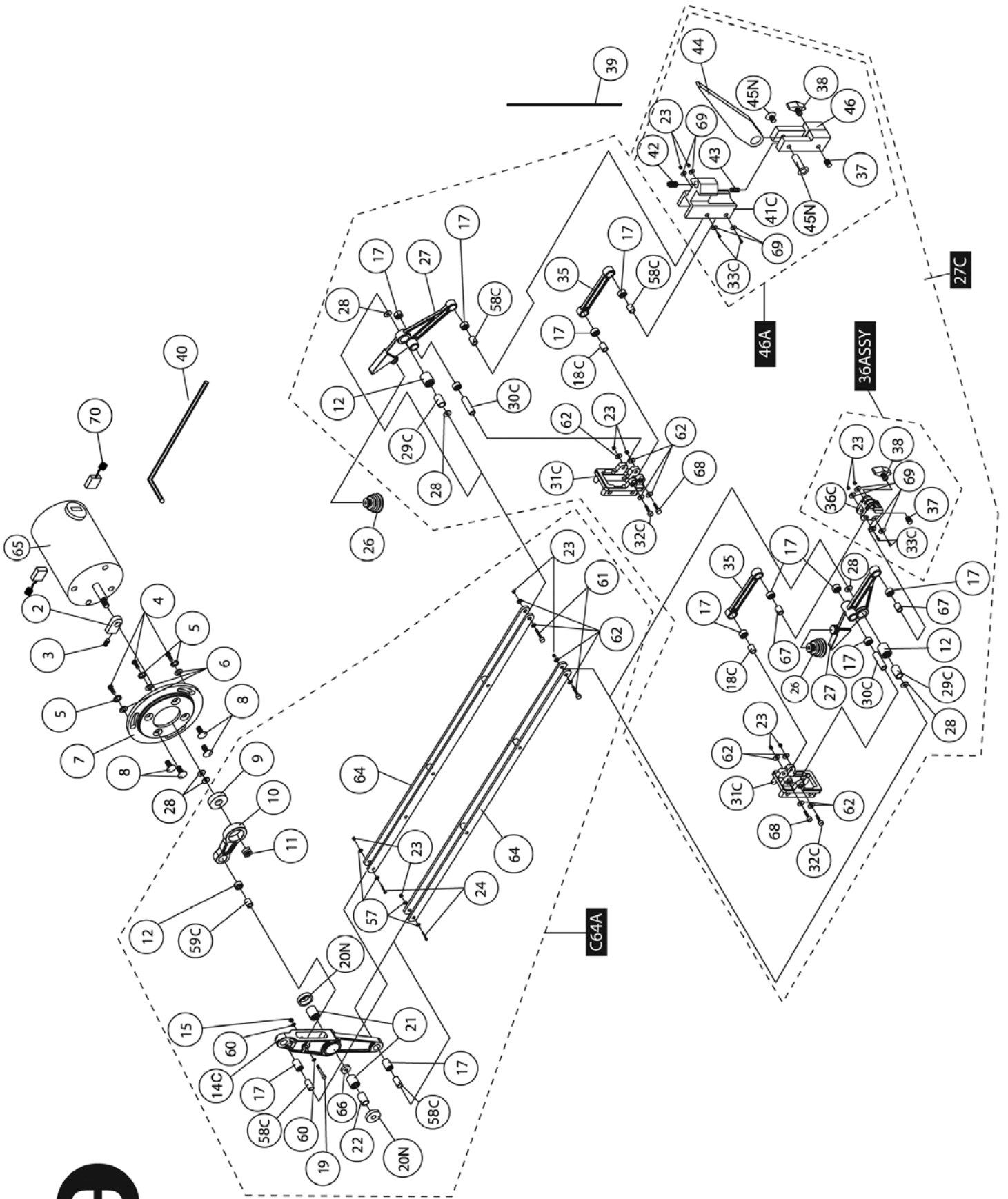

# EX-16, EX-21 EX-30 Drive Assembly Breakdown/List (C)

	Part No	Description	Specification	Qty
2	EX21-C02	BALANCE BLOCK		1
3	EX21-C03	SET SCREW	M6X6	1
4	EX21-C04	ALLEN SCREW	1/4-20X1/2	3
5	EX21-C05	LOCK WASHER	1/4	3
6	EX21-C06	FLAT WASHER	1/4X16X1.8	3
7	EX21-C07	MOTOR COVER PLATE		1
8	EX21-C08	SCREW	M6X16	4
9	EX21-C09	BEARING	608ZZ	1
10	EX21.C10	MOTOR CAM		1
11	EX21-C11	NUT	M8XP1.25LH	1
12	EX21-C12	BEARING	810	3
14C	EX21-C14C	ROCKER CAM		1
15	EX21-C15	LOCK NUT	M5	1
17	EX21-C17	BEARING	609	10
18C	EX21-C18C	BEARING INNER SLEEVE (SHORT)	06.03X21 MM	2
19	EX21-C19	CAP SCREW	M5X28	1
20N	EX21-C20N	BEARING COVER		2
21	EX21-C21	BEARING	1412	2
22	EX21-C22	MAIN ROCKER PIVOT	014.04X35.5MM	1
23	EX21-C23	NUT	M4	12
24	EX21-C24	CAP SCREW	M4X25	2
26	EX21-C26	AIR PUMP BELLOWS		2
27	EX21-C27	FRONT ROCKER		2
	EX21-C27C	UPPER AND LOWER ROCKER ASSEMBLY		1
28	EX21-C28	WASHER	M8 X 15 X 0.6	6
29C	EX21-C29C	INNER BEARING SLEEVE - FRONT ROCKER	08.03 X18.40MM	2
30C	EX21-C30C	BEARING INNER SLEEVE (LONG)	06.03 X 37MM	2
31C	EX21-C31C	ROCKER MOUNT		2
32C	EX21-C32C	CAP SCREW	M4X45	2
33C	EX21-C33C	CAP SCREW	M4X25	4
35	EX21-C35	STRUT		2
36C	EX21-C36C	BLADE CHUCK		1
	36ASSY EX21C-36ASSY BLADE CHUCK BOTTOM ASSEMBLY			1

	Part No	Description	Specification	Qty
37	EX21-C37	SET SCREW	M6X8	2
38	EX21-C38	BLADE CLAMP THUMB SCREW		2
39	EX21-C39	BLADE		1
40	EX21-C40	ALLEN KEY	3MM	1
41C	EX21-C41C	CLAMP BRACKET		1
42	EX21-C42	SET SCREW	1/4-20UNC	1
43	EX21-C43	SPRING		1
44	EX21-C44	TENSION LEVER (FOR EX-16 & EX-21)	5MM	1
	EX30-C44	TENSION LEVER (FOR EX-30)	7MM	1
45N	EX21-C45	SCREW POST	5X18	1
46	EX21-C46	SLIDING BRACKET		1
46A	EX21-C46A	UPPER BLADE TENSION ASSEMBLY (FOR EX-16 & EX-21)		1
	EX30-C46A	UPPER BLADE TENSION ASSEMBLY (FOR EX-30)		1
57	EX21-C57	WASHER	M4X10X1	4
58C	EX21-C58C	INNER BEARING SLEEVE (LONG)	06.02 X 16.50MM	4
59C	EX21-C59C	BEARING INNER SLEEVE	08.03X21.50MM	1
60	EX21-C60	WASHER	M5	2
61	EX21-C61	CAP SCREW	M4X27	2
62	EX21-C62	WASHER	M4X14X 1	12
64	EX16-C64	DRIVE LINK ASS'Y (LONG)		2
	EX21-C64	DRIVE LINK ASS'Y (LONG)		2
	EX30-C64	DRIVE LINK ASS'Y (LONG)		2
	EX16C64A	LINKAGE ASSEMBLY		1
	EX21-C64A	LINKAGE ASSEMBLY		1
	EX30-C64A	LINKAGE ASSEMBLY		1
65	EX21-C65	MOTOR		1
66	EX21-C66	SPACER		1
67	EX21-C67	BEARING INNER SLEEVE (SHORT)	06.03 X16MM	2
68	EX21-C68	CAP SCREW	M4X30	2
69	EX21-C69	WASHER	M4 X 8 X 1	8
70	EX21-70	CARBON BRUSH		2



**IMPORTANT: When ordering replacement parts, always give the model number, serial number of the machine and part number. Also a brief description of each item and quantity desired.**

# Wiring Diagram

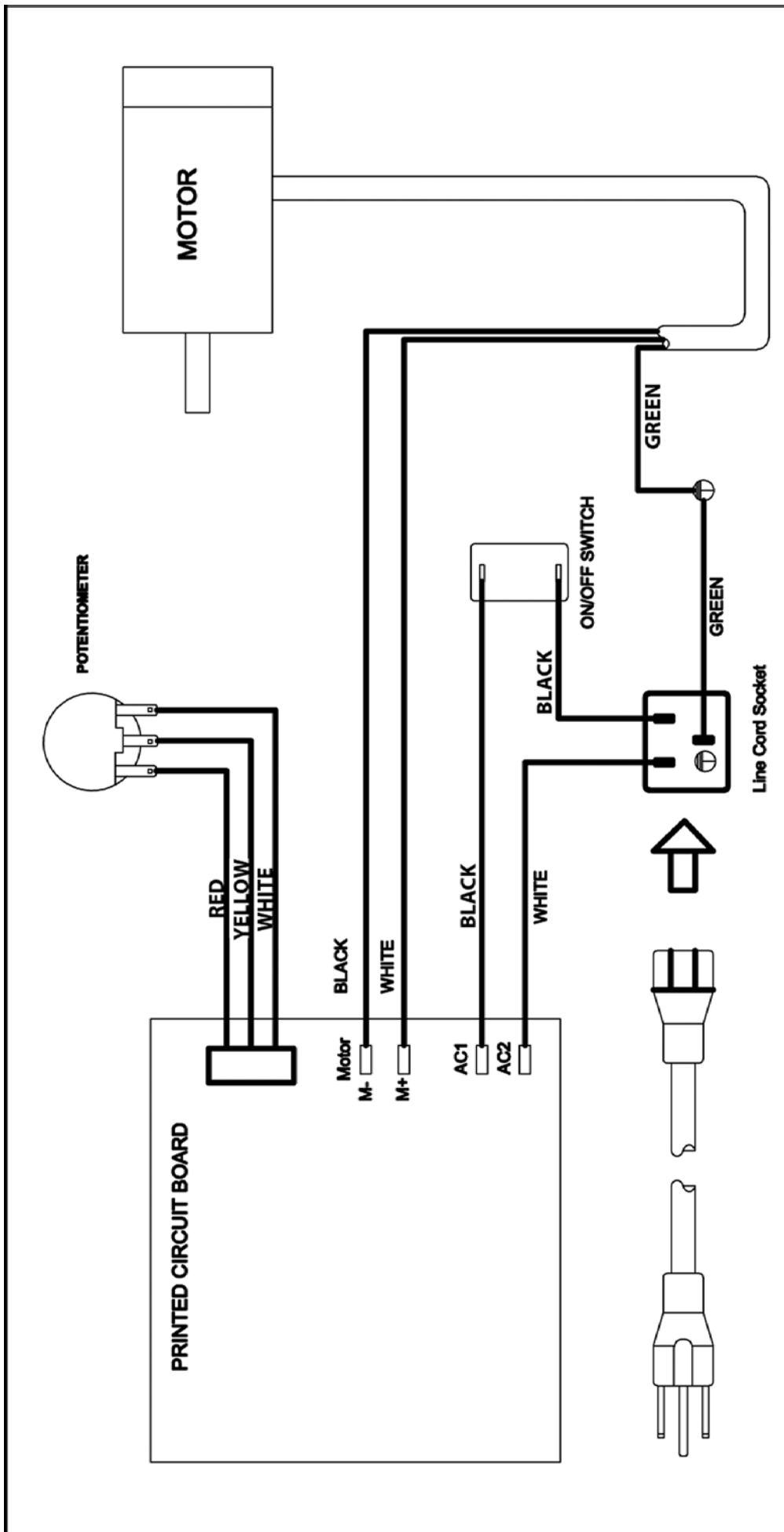











Please dispose of packaging for the product in a responsible manner. It is suitable for recycling. Help to protect the environment, take the packaging to the local recycling centre and place into the appropriate recycling bin.

**Only for EU countries**



Do not dispose of electric tools together with household waste material. In observance of European Directive 2002/96/EC on waste electrical and electronic equipment and its implementation in accordance with national law, electric tools that have reached the end of their life must be collected separately and returned to an environmentally compatible recycling facility.